



3 LEADING BRANDS

KOFU
REED SWITCHES

MEDER
electronic
REED SWITCHES

KENT
REED SWITCHES

Reed Technology



Reed Switch Characteristics
 Reed Switch Operational Characteristics 7
 The Basic Reed Switch 8
 Basic Electrical Parameters of Reed Switch Products 10
 How Reed Switches are used with a Permanent Magnet 18
 Reed Sensors vs. Hall Effect Sensors 25
 Reed Switches vs. Mechanical Switches 28

About Magnets
 Magnets and their Specifications 29
 Handling Information for Magnets 34
 Magnetization 35

Precautions
 Handling and Load Precautions when using Reed Switches in various Sensor and Relay Applications . . 37
 Contact Protection – Load Switching and Contact Protection 41
 Contact Protection – Protection Circuitry 43

Ampere-Turns (AT) versus Millitesla (mT)
 A Comparison of Ampere-Turns (AT) and Millitesla (mT) 45

Application Examples
 Applications for Reed Switches and Reed Sensors 51
 Automotive and Transportation 53
 Marine and Boat 56
 Smart Home 57
 Security and Safety 60
 Medical 61
 Test and Measurement 62
 Telecommunication 63
 Additional Solutions 64

Reed Relays
 The Reed Switch used as a Reed Relay 65
 Reed Relay Applications 66
 Reducing Magnetic Interaction in Reed Relay Applications 67
 Reed Relay in Comparison with Solid-State and Mechanical Relay 73
 7 GHz RF Reed Relay – Applications 74
 Applications Notes for RF-Relay Measurement in both the Frequency and Time Domain 76

Life Test Data
 Life Requirements 85

Activate Distance 86

Glossary 90

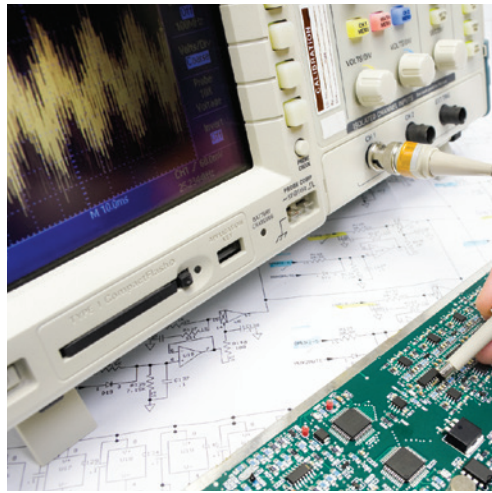

PRODUCT SOLUTIONS.
AS DIVERSE AS
THE MARKETS
WE SERVE.



OUR COMPANY

Standex Electronics is a worldwide market leader in the design, development and manufacture of standard and custom electro-magnetic components, including magnetics products and reed switch-based solutions.

Our magnetic offerings include planar, Rogowski, current, and low- and high-frequency transformers and inductors. Our reed switch-based solutions include KENT, MEDER and KOFU brand reed switches, as well as a complete portfolio of reed relays, and a comprehensive array of fluid level, proximity, motion, water flow, HVAC condensate, hydraulic pressure differential, capacitive, conductive and inductive sensors.

MARKETS WE SERVE

We offer engineered product solutions for a broad spectrum of product applications in all major markets, including but not limited to:

- Aerospace
- Industrial/Power
- Alternative Energy
- Lighting
- Automatization
- Medical
- Automotive/Transportation
- Measuring & Control Technology
- Communication Technology
- Metering
- Fluid Flow
- Military
- Food Service
- Off Highway
- General Industrial
- Pool/Spa
- Heavy Duty Truck
- Recreational
- Household/Appliances
- Security/Safety
- HVAC/R
- Space
- Hydraulics and pneumatic actuators
- Test & Measurement
- Utilities/Smart Grid



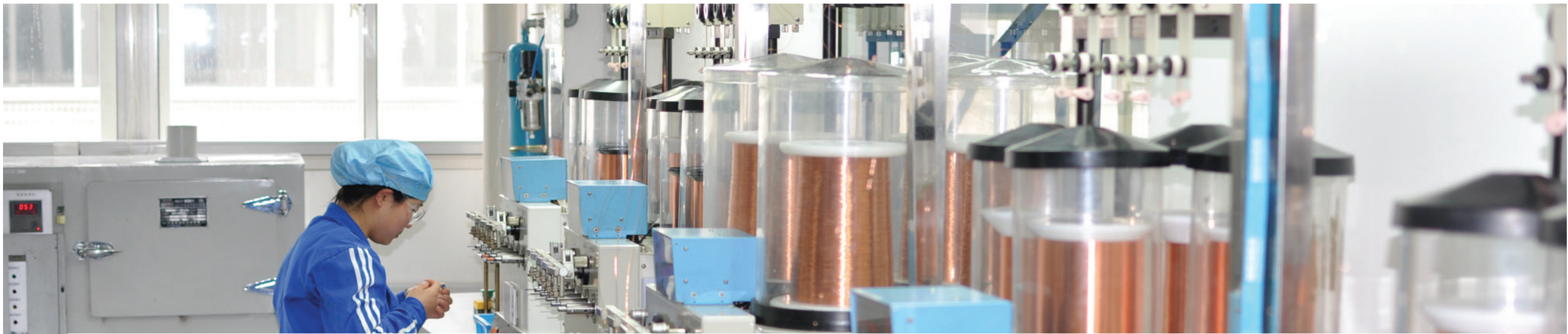

CUSTOMER DRIVEN INNOVATION. PREMIER WORLDWIDE CAPABILITIES.

COMMITMENT & EXPERTISE

Standex Electronics has a commitment to absolute customer satisfaction and customer-driven innovation, with a global organization that offers premier sales support, engineering capabilities, and technical resources worldwide.

Headquartered in Cincinnati, Ohio, USA, Standex Electronics has eight manufacturing facilities in six countries, located in the United States, Germany, China, Mexico, the United Kingdom, and Japan

MANUFACTURING

- Auto AT Switch Sorting
- Bobbin and Toroidal Winding
- Auto Termination

- Coil Molding & Packaging
- Insert and Thermoset Molding
- Low Pressure Molding (Hot Melt)
- Pick & Place – Vision & Camera System
- Plasma Surface Treatment
- Plastic Injection Molding
- Potting - 2 Component
- Progressive Stamping
- Reflow Oven – Multiple Zone Convection
- Reed Switch Manufacturing
- Reed Relay Design and Manufacturing - SMD, Low Thermal, High Insulation, High Voltage, High Frequency, Latching and Atex
- Selective Soldering
- Sensor Packaging

- Stainless Steel Fabrication and Precise Laser Welding
- Transformer Design And Manufacturing
- Wave Soldering

- Fluxmeters
- Nanovoltmeters
- Picoammeters
- Destructive Pull Testers
- Gauss / Teslameters

ENGINEERING

- Electronic sensor engineering
- Circuit Design and PCB Layout
- Patented Conductivity Sensors
- Patented Inductive Sensors
- 3-D CAD Modeling
- 3-D Magnetic Sensor Mapping
- EMS Software
- PCB Prototyper
- Quick Turn Samples
- 3-D Printing

TESTING & TOOLING

- Automated Assembly and Test Systems
- Environmental and Durability Testing
- Life Testing
- Network Analyzers

QUALITY/ LAB CAPABILITIES

- Certifications: AS9100, ITAR, ISO9000, TS16949
- SPC Data Collection
- Fully Equipped Certified Test Labs
- Burn-in and Life Testing
- Complete, In-House Machine Shop
- Corona Discharge Testing Capabilities
- Microscopic Investigation / DPA
- Moisture Resistance and Seal Testing
- Radiographic
- Salt Fog and Solderability
- Scott T Angular Accuracy
- Terminal Strength
- Thermal Cycling
- Mechanical and Thermal Shock, Temperature Rise and Vibration

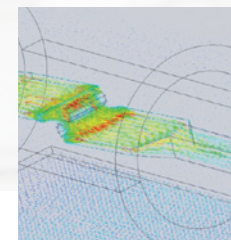
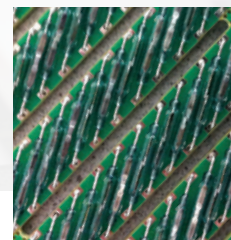
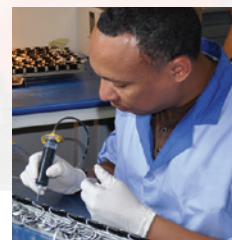
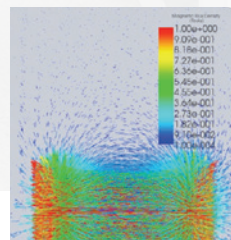

Notes

Reed Switch Operational Characteristics

The Reed Switch was first invented by Bell Labs in the late 1930s. However, it was not until the 1940s when it began to find application widely as a sensor and a Reed Relay. Here it was used in an assortment of stepping/switching applications, early electronic equipment and test equipment. In the late 1940s Western Electric began using Reed Relays in their central office telephone switching stations, where they are still used in some areas today. The Reed Switch greatly contributed to the development of telecommunications technology. Over the years several manufacturers have come and gone, some staying longer than they should have, tainting the marketplace with poor quality, and poor reliability. However, most of the manufacturers of Reed Switches today produce very high quality and very reliable switches. This has given rise to unprecedented growth. Today Reed Switch technology is used in all market segments including: test and measurement equipment, medical electronics, Telecom, automotive, security, appliances, general purpose, etc. Its growth rate is stronger than ever, where the world output cannot stay abreast with demand. As a technology, the Reed Switch is unique. Being hermetically sealed, it can exist or be used in almost any environment. Very simple in its structure, it crosses many technologies in its manufacture. Critical to its quality and reliability is its glass to metal hermetic seal, where the glass and metal used must have exact linear thermal coefficients of expansion. Otherwise, cracking and poor seals will result. Whether sputtered or plated, the process of applying the contact material, usually Rhodium or Ruthenium, must be carried out precisely in ultra clean environments similar to semiconductor technology. Like semiconductors, any foreign particles present in the manufacture will give rise to losses, quality and reliability problems.

To meet our customer's needs, Standex Electronics decided to build up their own assembly line. Reed Switches are produced since 1968 in England and since 2001 in Germany.

Over the years, the Reed Switch has shrunk in size from approximately 50 mm (2 inches) to 3.9 mm (0.15

inches). These smaller sizes have opened up many more applications particularly in RF and fast time domain requirements.

Reed Switch Features:

1. Ability to switch up to 10,000 Volts
2. Ability to switch currents up to 5 Amps
3. Ability to switch or carry as low as 10 nano-Volts without signal loss
4. Ability to switch or carry as low as 1 femtoAmp without signal loss
5. Ability to switch or carry up to 7 GigaHz with minimal signal loss
6. Isolation across the contacts up to 1015 W
7. Contact resistance (on resistance) typical 50 milliOhms (mW)
8. In its off state it requires no power or circuitry
9. Ability to offer a latching feature
10. Operate time in the 100 ms to 300 ms range
11. Ability to operate over extreme temperature ranges from -55 °C to +200 °C
12. Ability to operate in all types of environments including air, water, vacuum, oil, fuels, and dust laden atmospheres
13. Ability to withstand shocks up to 200 Gs
14. Ability to withstand vibration environments of 50 Hz to 2000 Hz at up to 30 g
15. Long life. With no wearing parts, load switching under 5 Volts at 10 mA, will operate well into the billions of operations
16. No power consumption, ideal for portable and battery-powered devices
17. No switching noise

The Basic Reed Switch

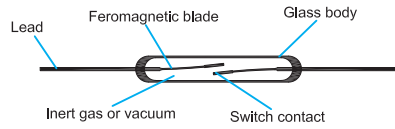

Fig. #1 The basic hermetically sealed Form 1A (normally open) Reed Switch and its component makeup.

A Reed Switch consists of two ferromagnetic blades (generally composed of iron and nickel) hermetically sealed in a glass capsule. The blades overlap internally in the glass capsule with a gap between them, and make contact with each other when in the presence of a suitable magnetic field. The contact area on both blades is plated or sputtered with a very hard metal, usually Rhodium or Ruthenium. These very hard metals give rise to the potential of very long life times if the contacts are not switched with heavy loads. The gas in the capsule usually consists of Nitrogen or some equivalent inert gas. Some Reed Switches, to increase their ability to switch (up to 10 kV) and standoff high voltages, have an internal vacuum. The reed blades act as magnetic flux conductors when exposed to an external magnetic field from either a permanent magnet or an electromagnetic coil. Poles of opposite polarity are created and the contacts close when the magnetic force exceeds the spring force of the reed blades. As the external magnetic field is reduced so that the force between the reeds is less than the restoring force of the reed blades, the contacts open.

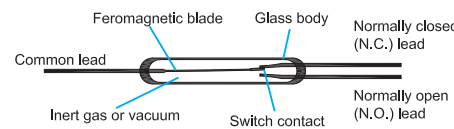

Fig. #2 The 1 Form C (single pole double throw) three leaded Reed Switch and its component makeup.

The Reed Switch described above is a 1 Form A (normally open (N.O.) or Single Pole Single Throw (SPST)) Reed Switch. Multiple switch usage in a given configuration is described as 2 Form A (two normally open switches or Double Pole Single Throw (DPST)), 3 Form A (three normally open switches), etc. A normally closed (N.C.) switch is described as a 1 Form B. A switch with a common blade, a normally open blade and a normally closed blade (Figure #2) is described as a 1 Form C (single pole double throw (SPDT)).

The common blade (or armature blade), the only moving reed blade, is connected to the normally closed blade in the absence of a magnetic field. When a magnetic field of sufficient strength is present, the common blade swings over to the normally open blade. The normally open and normally closed blades always remain stationary. All three reed blades are ferromagnetic; however, the contact area of the normally closed contact is a non-magnetic metal which has been welded to the ferromagnetic blade. When exposed to a magnetic field, both of the fixed reeds assume the same polarity which is opposite to that of the armature. The paddle then moves over to the normally open blade.

Figure 3 shows the general function of a Reed Switch with the use of a permanent magnet.

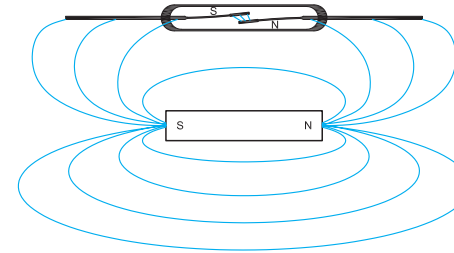

Fig. #3 The basic operation of a Reed Switch under the influence of the magnetic field of a permanent magnet. The polarization of the reed blades occurs in such a manner to offer an attractive force at the reed contacts.

The use of a coil wound with copper insulated wire. See Figure 4.

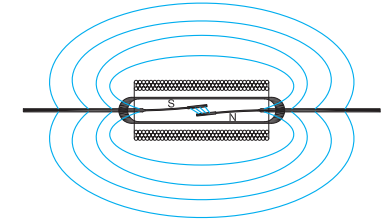

Fig. #4 A Reed Switch sitting in a solenoid where the magnetic field is strongest in its center. Here the reed blades become polarized and an attractive force exists across the contacts.

When a permanent magnet, as shown, is brought into the proximity of a Reed Switch the individual reeds become magnetized with the attractive magnetic polarity as shown. When the external magnetic field becomes strong enough the magnetic force of attraction closes the blades. The reed blades are annealed and processed to remove any magnetic retentivity. When the magnetic field is withdrawn the magnetic field on the reed blades also dissipates. If any residual magnetism existed on the reed blades, it would affect the behavior of opening and closing. Proper processing and proper annealing clearly are important steps in their manufacturing.

Basic Electrical Parameters of Reed Switch Products

Pull-In (PI) is described as that point where the contacts close. Using a magnet, it is usually measured as a distance from the Reed Switch to the magnet in mm (inches) or in field strength AT, mTesla, or Gauss. In a coil, the Pull-In is measured in volts across the coil, mA flowing in the coil, or ampere-turns (AT). Generally, this parameter is specified as a maximum. No matter how well the reed blades are annealed, they will still have a slight amount of retentivity (a slight amount of magnetism left in the blades after the magnetic field is removed or eliminated from the Reed Switch). To obtain consistent Pull-In and Drop-out results, saturating the Reed Switch with a strong magnetic field first, before taking the Pull-In measurement will produce more consistent results. See Figure #5.

When measured in a coil, or specifically, a Reed Relay, the Pull-in is subject to changes at different temperatures, and is usually specified at 20° C. See Figure #6.

Pull-in/Drop-out Temperature Effects

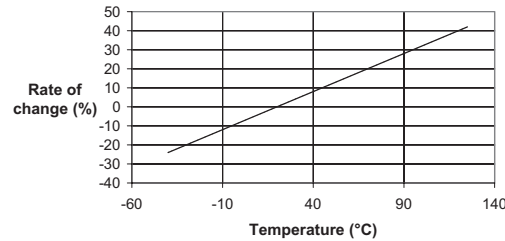

Fig. #6 The Pull-In and Drop-Out points will change with temperature at the rate of 0.4% /°C.

Here, because the copper coil wire expands and contracts with temperature, the Pull-In or operate point will vary with temperature by 0.4% oC. Well designed relays usually take this parametric change into consideration in the design and specification.

Drop-Out (DO) is described as that point where the contacts open and has similar characteristics as the Pull-In above. It is also described as release or reset voltage current or AT.

Hysteresis exists between the Pull-In and Drop-Out and is usually described in the ratio DO/PI expressed in %. The hysteresis can vary depending upon the Reed Switch design, (Figure #7), where variations in plating or sputtering thickness, blade stiffness, blade overlap, blade length, gap size, seal length, etc. will all influence this parameter. See Figure 7 for example of hysteresis when using a magnet to handle a Reed Switch.

Drop-out vs. Pull-in

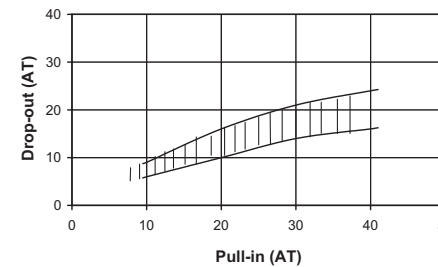

Fig. #7 The Pull-in and Drop-out ranges are shown. Note that variation in hysteresis is for low ampere turns (AT) is very small and increases with higher AT.

Contact Resistance is the DC resistance generated by the reed blades (bulk resistance) and the resistance across the contact gap. Most of the contact resistance resides in the nickle/iron reed blades. Their resistivity is 7.8×10^{-8} Ohm/m and 10.0×10^{-8} Ohm/m respectively. These are relatively high when compared to the resistivity of copper, which is 1.7×10^{-8} Ohm/m. Typical contact resistance for a Reed Switch is approximately 70 mOhm, 10 to 25 mOhm of which is the actual resistance across the contacts. In a Reed Relay, many times the relay pins will be nickle/iron improving the overall mag-netic efficiency but adding bulk resistance to the contact resistance. This increase can be in the order of 25 mOhm to 50 mOhm. See Figure #8.

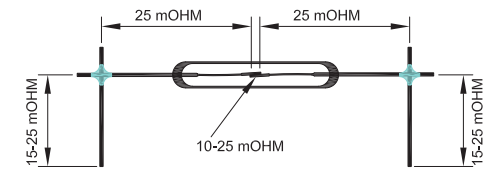

Fig. #8 A representation of the bulk resistance and resistance across the contacts making up the contact resistance value in Ohms for a Reed Switch

Dynamic Contact Resistance (DCR) is a true measure of the disposition of the contacts. As already described, the contact resistance is mostly made up of bulk resistance or lead resistance. Measuring the resistance across the Reed Switch only gives gross indication that the contacts are functional. To give a better indication of the contacts functionality, one must look at the contacts under dynamic conditions.

Opening and closing the contacts at frequencies in the range of 50 Hz to 200 Hz can reveal much more information. Switching 0.5 Volts or less with approximately 50 mA will allow enough voltage and current to detect potential problems. This testing can be carried out using an oscilloscope or may be easily digitized for more automatic testing. One should avoid test voltages greater than 0.5 Volts to avoid 'break-over' (potential non-conductive films). This extremely thin film will look like an open circuit if one is switching very low signals or in current less closing of the Reed Switch (closing the contacts before any voltage or current is applied across the contacts). Using a voltage above 0.5 V might hide this potential quality problem. See Figure 9.

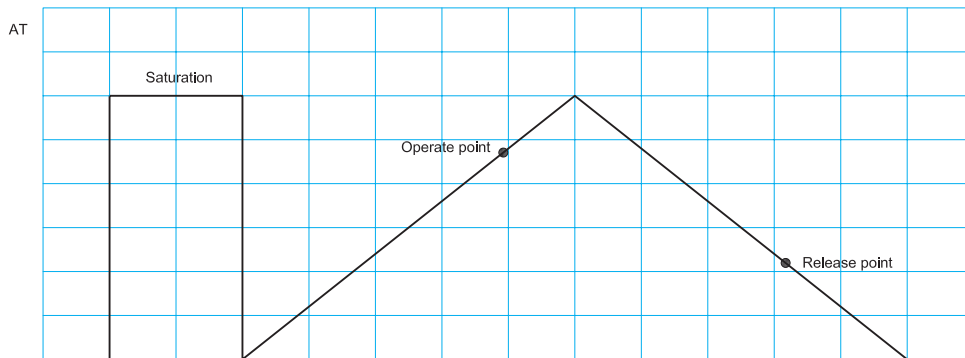

Fig. #5 For most accurate results, saturate the contrast with a magnetic field, before testing for Pull-In and Drop-Out.

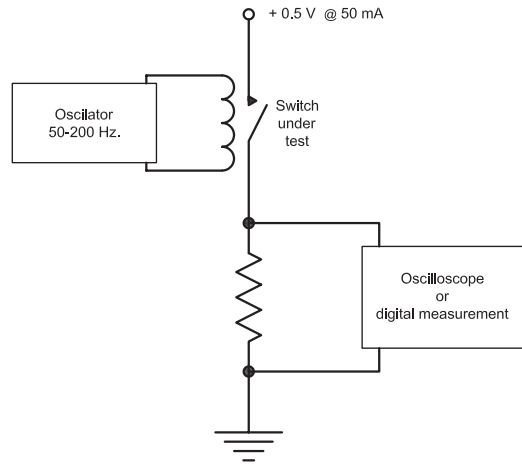

Fig. #9 A schematic diagram of a typical circuit used for measuring the dynamic contact resistance across the contacts of a Reed Switch.

Applying the frequency described above to a coil, the contacts will operate and close in approximately 1/2 mA. The contacts may then bounce for about 100ms and undergo a period of dynamic noise for as much as 1/2 ms. This dynamic noise is generated by the contacts continuing to bounce but not opening, whereby the contact resistance varies widely where the force or pressure on the contacts varies harmonically, critically dampening in about 1/2 ms or less. See Figure 10. Once this dynamic noise dissipates, the contacts will then undergo a “waver period”. Here the contacts have closed, but will waver while closed for up to 1 ms or more. This wavering of the contacts in the coil’s magnetic field generates a current through the contacts. Once this effect dissipates the contacts enter their static condition.

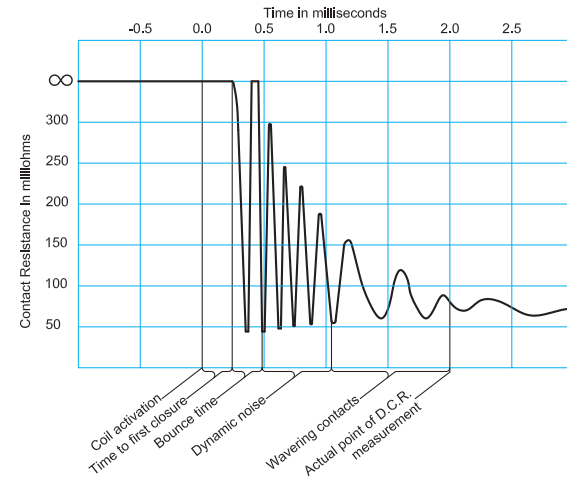

Fig. #10 A typical dynamic contact resistance portrayal showing the first closure, bouncing, dynamic noise and pattern generated by waver-ing contacts

Observing the electrical pattern produced by this dynamic test can reveal much about the quality of the Reed Switch. Generally speaking, once the coil voltage has been applied, the dynamic contact activity should settle down by 1 1/2 ms. If the contacts continue to bounce more than 250 ms, the closing force may be weak, which may result in a shortened life, particularly if one is switching a load of any size. See Figure #11.

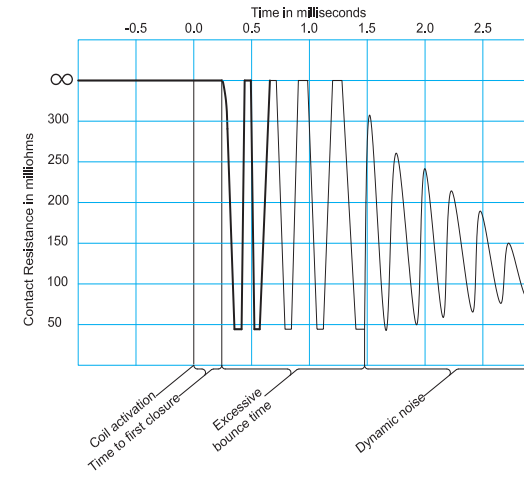

Fig. #11 A dynamic contact resistance pattern showing excessive contact bounce.

If the dynamic noise or the wavering contacts continue for periods longer than indicated, it may mean the Reed Switch seals are weak or perhaps overstressed. This could result in capsule cracking or breaking. Also, if the wavering produced has excessive amplitude, this could represent a condition of capsules having added stress which could produce leaking seals. In this case, outside air and moisture may seep into the capsule producing unwanted contamination on the contacts. See Figure #12 & #13.

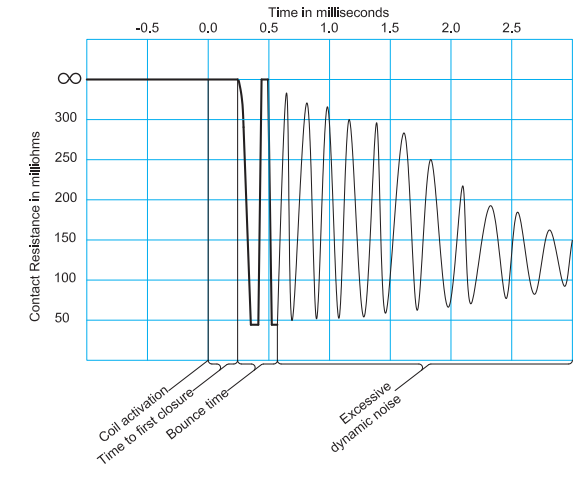

Fig. #12 A dynamic contact resistance pattern portraying excessive dynamic noise indicating potential stressed or cracked glass seal.

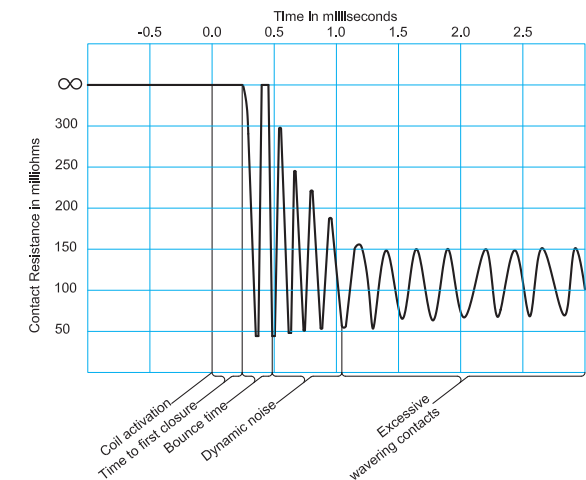

Fig. #13 A dynamic contact resistance pattern with indicated excessive contact wavering often indicates a stressed or cracked glass seal.

Also, when the contact resistance varies by a small degree with successive closures, contamination, a leaking seal, particles, loose or peeling plating may exist, potentially shortening life expectations (Figure #14). Varying the frequency applied to the coil sometimes produces more subtle awareness of resonance related problems. This will also manifest itself with higher amplitude or longer times of dynamic noise or contact wavering.

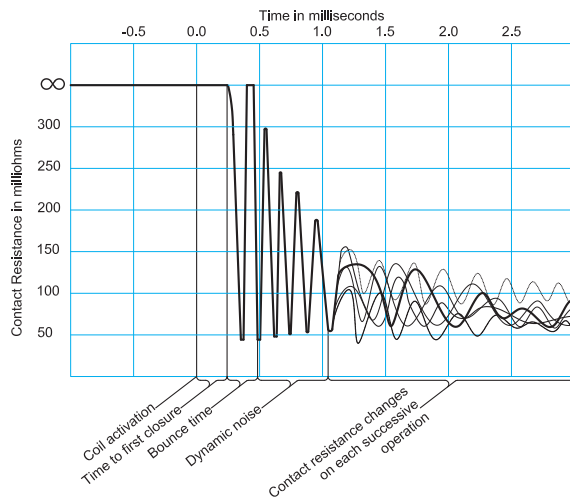

Fig. #14 A dynamic contact resistance pattern showing contact resistance changing in each successive operation indicating contact contamination.

Any time long life, stable contact resistance, and fault free operation are conditions in your application, dynamically testing the contacts and having tight testing limits are a must.

Switching Voltage, usually specified as a maximum in units of Volts DC or Volts peak, is the maximum allowable voltage capable of being switched across the contacts. Switching voltages above the arcing potential can cause some metal transfer. The arc potential generally occurs over 5 Volts. Arcing is the chief cause of shorted

life across the contacts. In the 5 V to 12 V range most contacts are capable of switching well into the tens of millions of operations depending on the amount of current switched. Most pressurized Reed Switches can not switch more than

500 Volts, principally because they can not break the arc occurring when one tries to open the contacts. Generally, switching above 500 Volts requires evacuated Reed Switches, where up to 10,000 Volts is possible. Switching below 5 Volts, no arcing occurs and therefore no blade wear occurs, extending Reed Switch lifetimes well into the billions of operations. Properly designed Reed Relays can switch and discern voltages as low as 10 nanoVolts.

Switching Current refers to that current measured in Amperes DC (peak AC), switched at the point of closure of the contacts. The higher the level of current the more sustained the arcing at opening and closing and therefore the shorter the life of the switch.

Carry Current, also measured in Amperes DC (peak AC), is specified as the maximum current allowed when the contacts are already closed. Since the contacts are closed, higher currents are allowed. No contact damage can occur, since the only time arcing occurs is during the opening and closing transitions. A Reed Switch is also able to transport higher currents, when the pulse duration is very short, since the heating here is minimal. Conversely, unlike electromechanical armature style relays, the Reed Relay can switch or carry currents as low as femptoAmperes (10-15 Amperes).

Stray Capacitance measured in microFarads or Pico Farads is always present for example due to conducting paths and cable. When switching voltage and current, the first 50 nanoSeconds are the most important. This is where the arcing will occur. If there is a significant amount (depending on the amount of voltage switched) of stray capacitance in the switching circuit, a much greater arc may occur, and thereby reducing life. When switching any sizable voltage, it is always a smart idea to place

a fast current probe in the circuit to see exactly what one is switching in the first 50 nanoSeconds. Generally speaking, when switching voltages over 50 Volts, 50 picoFarads or more can be very significant to the expected life of the switch.

Common Mode Voltage is also another parameter that can have a significant effect on the life of a Reed Switch. Depending upon the circuit and the environment, common mode voltages can in effect, charge stray capacitances in the switching circuit and dramatically reduce Reed Switch life in an unexpected manner. Again, a fast current probe can reveal a startling voltage and current switched in that first 50 nanoSeconds, having no bearing on one's actual load. When line voltages are present in or near sensitive circuits, be cautious. Those voltages can be coupled into the circuit creating havoc with your life requirements. Typically, a faulty Reed Switch is blamed for this reduced life, when in actuality, it is a product of unforeseen conditions in the circuit.

Switching Load is the combined voltage and current switched at the time of closure. Sometimes there is confusion with this parameter. For a given switch, with a switching rating of 200 Volts, 0.5 Amperes and 10 Watts, any voltage or current switched, when multiplied together, can not exceed 10 Watts. If you are switching 200 Volts, then you can only switch 50 milliAmperes. If you are switching 0.5 Amperes, then you can only switch 20 Volts.

Breakdown Voltage (Dielectric Voltage) generally is higher than the switching voltage. On larger evacuated Reed Switches, ratings as high as 15,000 Volts DC are not uncommon. Some smaller evacuated reeds can stand off up to 4000 Volts DC. Small pressurized reed switches generally withstand 250 to 600 Volts DC.

Insulation Resistance is the measure of isolation across the contacts and is probably one of the most unique parameters that separate Reed Switches from all other switching devices. Typically, Reed Switches have insulation resistances averaging 1×10^{14} ohms.

This isolation allows usage in extreme measurement conditions where leakage currents in the picoAmpere or femtoAmpere range would interfere with the measurements being taken. When testing semi-conductors, one may have several gates in parallel where the switching devices have combined leakage currents that become significant in the test measurement circuit.

Dielectric Absorption describes the effect different dielectrics have on very small currents. Currents below 1 nanoAmpere are affected by the dielectric's tendency to slow or delay these currents. Depending upon how low a current one is measuring, these delays can be on the order of several seconds. Standex Electronics engineers have designed Reed Relays and circuits to minimize dielectric absorption.

Operate Time is the time it takes to close the contacts and stop bouncing. Except for mercury wetted contacts, when the reed blades close, they close with enough force to set them in harmonic motion. This critically damped motion dissipates rapidly due to the relatively strong spring force of the reed blades. One generally sees one or two bounces occurring over a 50 ms to 100 ms period. Most small Reed Switches operate, including bounce, in the range of 100 ms to 500 ms. See Figure #15.

Release Time is the time it takes for the contacts to open after the magnetic field is removed. In a relay, when the coil turns off, a large negative inductive pulse ('kick') occurs causing the reed blades to open very rapidly. This release time may be in the order of 20 ms to 50 ms. If a diode is placed across the coil to remove this inductive voltage spike (which can be 100 Volts to 200 Volts), the contact opening time will slow to about 300 ms. Some designers require the fast release time, but cannot have the high negative pulses potentially being coupled into sensitive digital circuitry. So they add a 12 Volt to 24 Volt zener diode in series with a diode, all of which is in parallel across the coil. Here, when the coil is turned off, the voltage is allowed to go negative by the zener voltage value, which is sufficient to cause the contacts to open generally under 100 ms. See Figure #16.

Resonant Frequency for a Reed Switch is that physical characteristic where all reed parameters may be affected at the exact resonance point of the Reed Switch. Reed capsules 20 mm long will typically resonate in the 1500 to 2000 Hz range; reed capsules on the order of 10 mm will resonate in the 7000 to 8000 Hz range. Avoiding these specific resonance areas will insure a fault free environment for the Reed Switch. Parameters typically affected are the switching voltage and the breakdown voltage. See Figure #17.

Capacitance across the contacts is measured in picoFarads and ranges from 0.1 pF to 0.3 pF. This very low capacitance allows switching usage, where semiconductors having 100's of picoFarads, can not be considered. In semiconductor testers, this low capacitance is absolutely critical. See Figure #18.

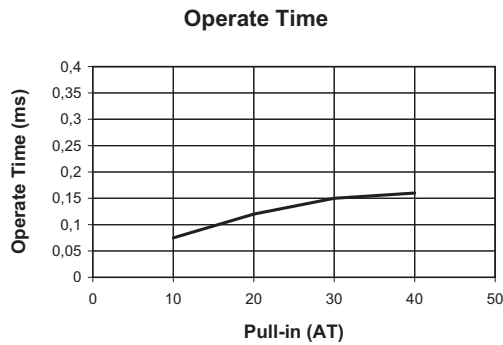

Fig. #15 A typical graph of the operate time for increasing Pull-In AT values. With higher Pull-in AT the Reed Switch gap increases taking a longer time for the contacts to close.

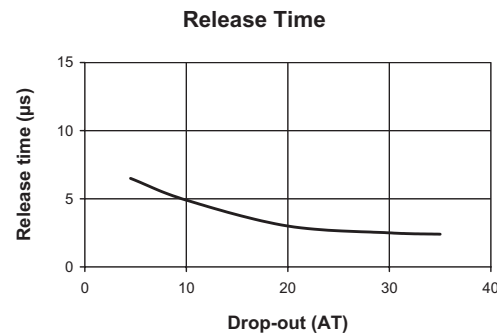

Fig. #16 A graph of the release time for increasing Dropout AT. With increasing Drop-out AT the restoring force increases causing even faster release time.

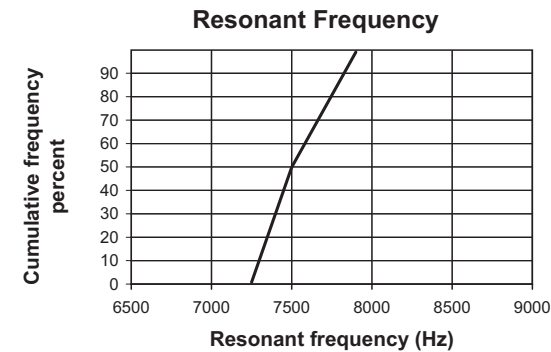

Fig. #17. A depiction of a group of 10 mm Reed Switches and its resonant frequency distribution.

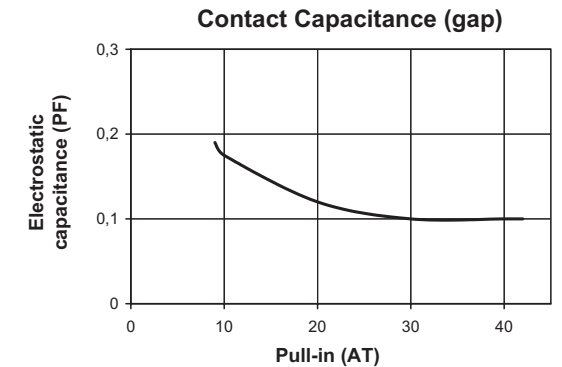

Fig. #18 As the Pull-in AT increases its gap increases, therefore reducing the capacitance across the Reed Switch.

How Reed Switches are used with a Permanent Magnet

Using Reed Switches in a sensing environment, one generally uses a magnet for actuation. It is important to understand this interaction clearly for proper sensor functioning. Sensors may operate in a normally open, normally closed, change over or a latching mode.

In the normally open mode, when a magnet is brought toward the Reed Switch the reed blades will close. When the magnet is withdrawn the reed blades will open. With the normally closed sensor, bringing a magnet to the Reed Switch the reed blades will open, and withdrawing the magnet, the reed blades will re-close. In a latching mode the reed blades are in either an open or closed state. When a magnet is brought close to the Reed Switch the contacts will change their state. If they were initially open, the contacts will close. Withdrawing the magnet the contacts will remain closed. When the magnet is again brought close to the Reed Switch, with a changed magnetic polarity, the contacts will now open. Withdrawing the magnet the contacts will remain open. Again, reversing the magnetic polarity, and bringing the magnet again close to the Reed Switch the contacts will again close and remain closed when the magnet is withdrawn. In this manner, one has a latching sensor or a bi-stable state sensor. In the following diagrams, we will outline the guidelines one must be aware of when using a magnet. Please keep in mind the magnetic field is three-dimensional.

A permanent magnet is the most common source for operating the Reed Switch. The methods used depend on the actual application. Some of these methods are the following: front to back motion. See Figure #19.

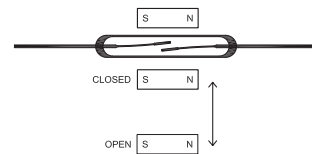

Fig. #19 A Reed switch being shown with a magnet being moved in front to back motion.

Rotary motion (see below Figure #20); ring magnet with parallel motion (see Figure #21)

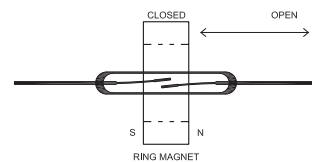

Fig. #21 A circular magnet showing a Reed Switch effectively passing through its centers showing the opening and closing points.

The use of a magnetic shield to deflect the magnetic flux flow. See Figure #22.

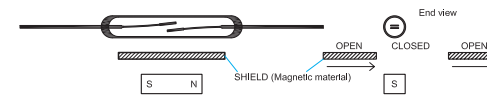

Fig. #22 The effects of a magnetic shield passing between a Reed Switch and permanent magnet shunting the magnetic lines of flux which influences the opening and closing of the Reed Switch.

Pivoted motion about an axis. See Figure #23.

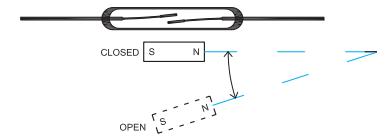

Fig. #23 A pivoting magnet is shown influencing the opening and closing points of a Reed Switch.

Parallel motion (Figure #24, Figure #25, Figure #26, Figure #27, Figure #28) and combinations of the above perpendicular motion (Figure #29, Figure #30, Figure #31 and Figure #32).

Before we investigate each of these approaches, it is important to understand the fields associated with the various Reed Switch vs. magnet positions and their on/off domain characteristics. The actual closure and opening points will vary considerably for different Reed Switches and different sizes and strengths of magnets.

First consider the case where the magnet and Reed Switch are parallel. In Figure #24, the open and closure domains are shown in the x and y-axis. These domains represent the physical positioning of the magnet relative to the Reed Switch along the x-axis. The closure and opening points are relative to the movement of the magnet along this x axis, where the magnet is fixed relative

to the y-axis. Here, three domains exist, wherein Reed Switch closure can take place. Keep in mind the center domain is much stronger and the graph gives a relative idea of the closure points on a distance basis along the y-axis. The hold areas shown, demonstrates the hysteresis of the Reed Switch and will vary considerably for different Reed Switches. In fluid level controls, having a wider hold area can be beneficial, particularly if there is constant disruption to the fluid level as in a moving vehicle. Using the configuration shown in Figure #24, the maximum distance away from the Reed Switch for closure is possible. This approach has the best magnetic efficiency.

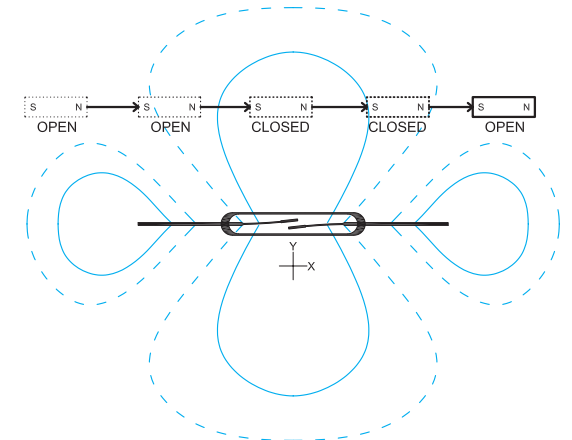

Fig. #24 The opening, closing and holding points are shown for a magnet passing in parallel to Reed Switch and being affected by the center magnetic lobe.

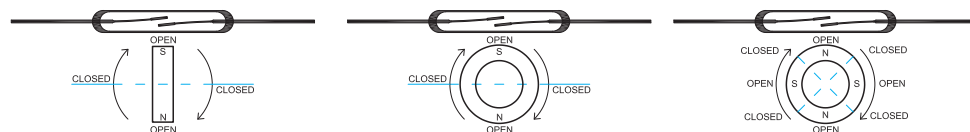

Fig. #20 A reed switch being used with magnets in rotary motion.

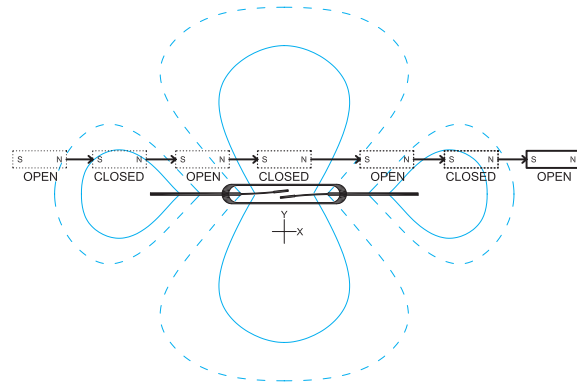

Fig. #25 The opening and closing points are shown for a magnet making a close approach in parallel to a Reed Switch. Here the Reed Switch will close and open three times.

Also, for parallel motion, if the magnet and switch are close enough, parallel motion can create three closures and openings as demonstrated in Figure #25.

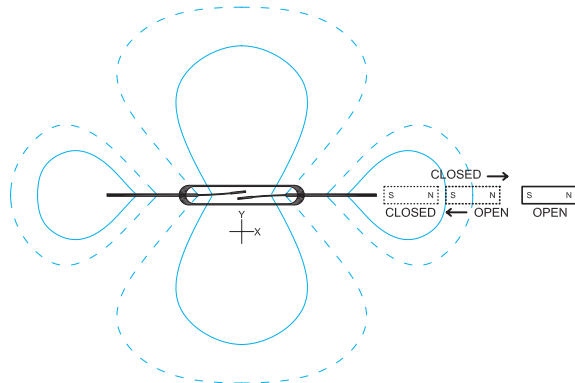

Fig. #26 The closing and opening is portrayed for a magnet approaching a Reed Switch in parallel from an end point.

Passing the magnet by the Reed Switch farther away, one closure and opening will occur. Another approach for magnets used in a parallel application with parallel motion is shown in Figure #26, where the closure point uses the smaller outer magnetic domain.

Another approach for magnets used in a parallel application, but with vertical motion, is shown in Figure #27 where the closure point uses the inner larger magnetic domain. In Figure #28 the vertical motion uses the outer magnetic domain.

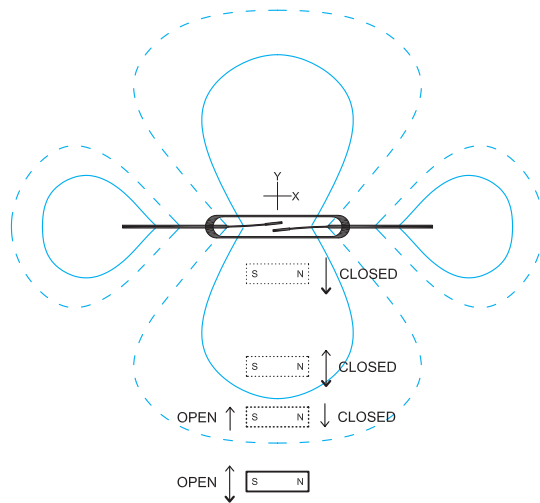

Fig. #27 The closing, holding, and opening are portrayed for a magnet parallel to the Reed Switch, but moving perpendicular to the plane of the Reed Switch and being influenced by the center magnet lobe.

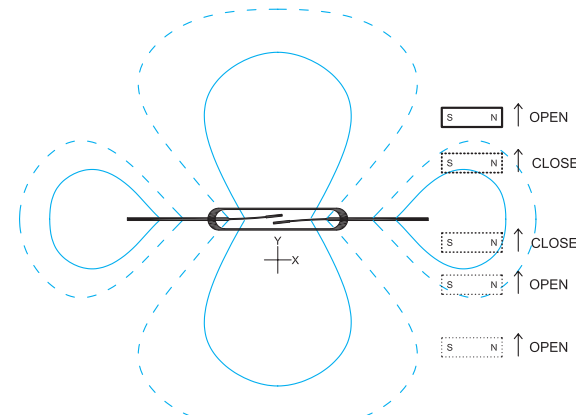

Fig. #28 The closing, holding, and opening are presented for a magnet parallel to the Reed Switch, but moving perpendicular to the plane of the Reed Switch and being influenced by the outer magnetic lobe.

Another approach for magnets used in a parallel application, but with vertical motion, is shown in Figure #29. Please note this view is showing the y-z-axis. The closure and opening states are clearly shown for several positions of the magnet.

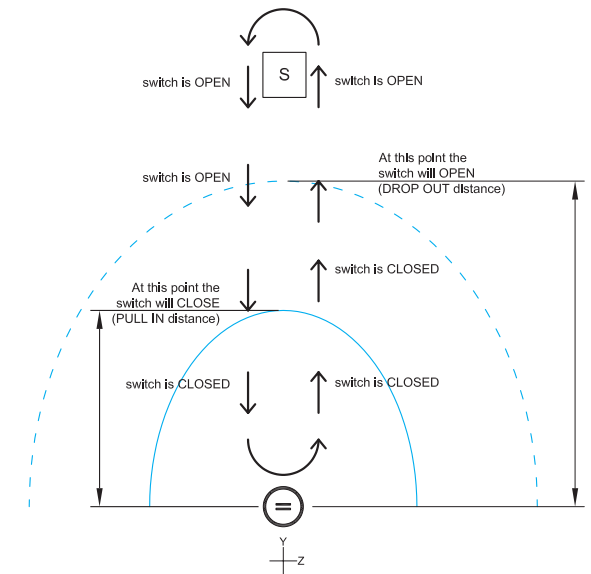

Fig. #29 Motion of the magnet is depicted in the y-z axis where the magnet is parallel to the Reed Switch, but moving perpendicular to its plane. The closure, holding, and opening points are shown.

In Figure #30, the magnet is perpendicular to the Reed Switch. Here the x-y axis is shown with the relative closure, holding and opening points. Parallel magnet movement is along the x-axis, but displaced at a distance y from the x-axis. Here two closures and openings can take place.

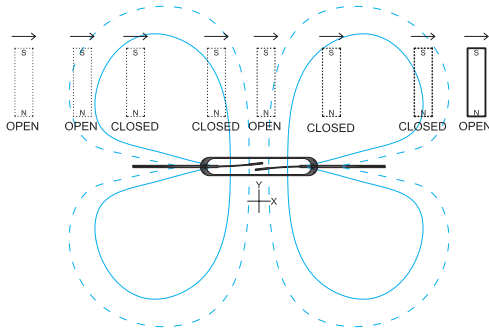

Fig. #30 The opening and closing points are shown for a vertically mounted magnet making an approach parallel to the Reed Switch. Here the Reed Switch will close and open two times.

In Figure #31, the magnet is again perpendicular to the Reed Switch. Magnet movement is still parallel but on and along the x-axis. No Reed Switch closure takes place.

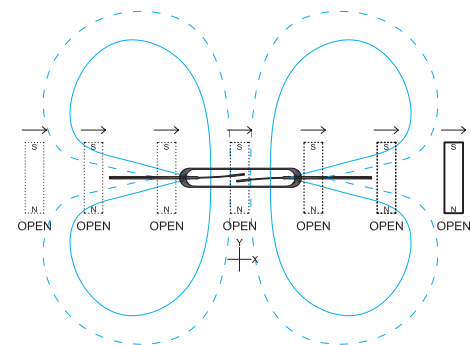

Fig. #31 The opening and closing points are shown for a vertically mounted magnet making an approach parallel to the axis of the Reed Switch. Here the Reed Switch will close and open two times.

In Figure #32, the magnet is perpendicular to the Reed Switch. Here the x-y axis is shown with the relative closure, holding and opening points. Magnet movement is along the y-axis, but displaced a distance x from the y-axis. Here two closures and openings can take place as shown.

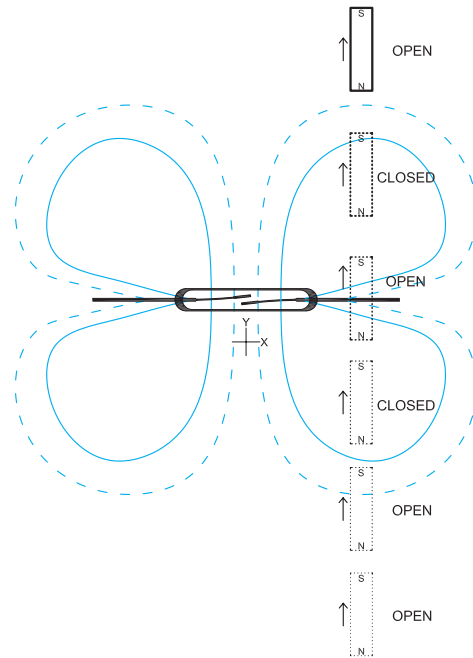

Figure #32 The opening and closing points are shown for a vertically mounted magnet making an approach perpendicular to the axis of the Reed Switch through its end point. Here the Reed Switch will close and open two times.

In Figure #33, the magnet is perpendicular to the Reed Switch. Here the x-y axis is shown with the relative magnet movement along the actual y-axis and the magnet movement is fixed relative to the x-axis. Here no closures take place.

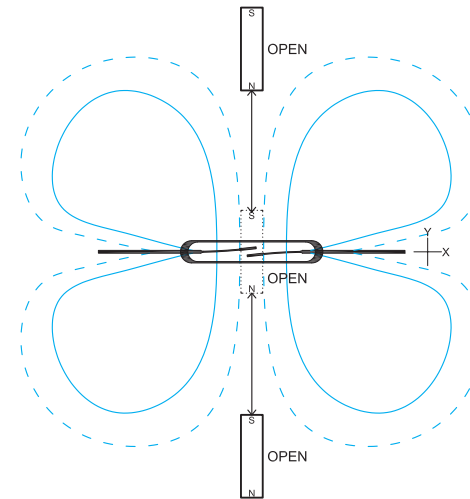

Fig. #33 No closure points are shown for a vertically mounted magnet making an approach perpendicular to the axis of the Reed Switch and through its center point. Here the Reed Switch will not close at all.

With the above closure and opening boundaries relative to magnet placement, an assortment of closure and open configurations can be set up when moving the magnet in more than one axis of motion, i.e. rotary motion, etc. Also, in the above cases we held the movement of the Reed Switch fixed in position. By holding the magnet fixed and moving the Reed Switch, if the application calls for it, the same expected closures and opening distances would be expected. There can be multiple poles existing in one magnet, and under these conditions the closure and opening points will change. Experimentation may be required to determine the closure and opening points. Biasing a Reed Switch with another magnet will allow normally closed operation. Bringing another magnet, of

opposite polarity, in close proximity to the magnet/Reed Switch assembly will open the contacts. See Figure #34.

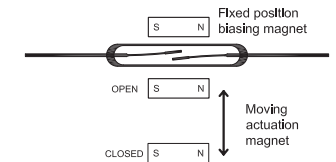

Fig. #34 A Reed Switch can be biased closed with a magnet. When a second magnet with an opposing magnetic field is brought close, the Reed Switch will open giving rise to a normally closed sensor.

Also, using a biasing magnet will allow Reed Switch operation in the hold area or hysteresis area, thereby creating a latching sensor. (see Figure #35) In this situation, real care needs to be taken in exact placement of the biasing magnet and the operating magnet needs to be restricted to certain areas. To switch from bi-stable state to bi-stable state the operating magnet's polarity or direction needs to be reversed.

Reed Sensors vs. Hall Effect Sensors

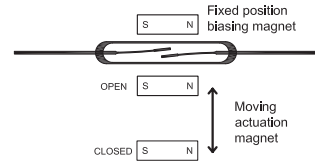

Fig. #35 A Reed Switch can be biased with a magnet in such a way to establish a latching sensor. When a second magnet with a given polarity is brought close, the contacts will close. Withdrawing the magnet the contacts stay closed. Bringing a magnet with opposite polarity close to the Reed Switch, the contacts will open and remain open when the magnet is withdrawn.

Standex Electronic has developed a bridging sensor which can operate in either a normally open or normally closed state. When a sheet of ferro-magnetic material (metal door, etc.) is brought up to the sensor the Reed Switch will close; when it is withdrawn, the contacts will open (Figure #36) No external magnets are required to operate the bridge sensor (see our MK02 Series).

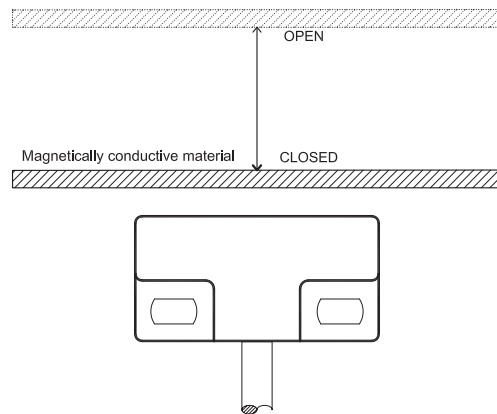

Fig. #36 Standex Electronics has designed a patented bridge sensor requiring no external magnets. When the sensor is brought close to a ferromagnetic sheet or plate the sensor contacts will close. When the sheet is withdrawn, the contacts will open.

Since their introduction several years ago, the Hall effect sensor has captured the imagination of design engineers. Generally, it was thought that if it's in solid state that it's a more reliable approach, particularly when comparing it to electromechanical devices. However, several remarkably interesting advantages are observed when comparing the reed sensor technology to the Hall effect technology.

But first, let's take a closer look at the reed sensor technology. The key component in the reed sensor is the reed switch, invented by Western Electric back in the 1930's. The other major component is the magnet or electromagnet used to open or close the reed switch. Over the last seventy years the reed switch has undergone several improvements, making it more reliable, improving its quality and reducing its cost. Because of these dramatic improvements of reed switches, they have become the design choice in several critical applications where quality, reliability and safety are paramount.

Perhaps the most dramatic application and testimony of the reed's quality and reliability is its use in Automatic Test Equipment (ATE). Here this technology is used exclusively. The reed switches are used in reed relays, switching in the various test configurations for integrated circuits, ASICs, wafer testing and functional printed circuit board testing. For these applications up to 20,000 reed relays may be used in one system. Here one relay failure constitutes a 50-ppm failure rate. Therefore to meet this requirement, the reed relays need to have quality levels much better than 50-ppm. Heretofore, it was unheard of to have an electromechanical device with this quality level. Similarly the same holds true for several semi conductor devices as well. Once beyond the initial operational quality testing, the reed relays then need to perform well over life. Here they have been proven to outperform all other switching devices. Because, in many cases the automatic test equipment is operated 24 hours a day and 7 days a week to fully utilize its high capital expense; and therefore, billions of operations may be required during the reed relay's lifetime.

Another example of its favored use is in air bag sensors, where they have passed the test of time in a crucial safety application. Reed sensors are currently used in many critical automotive safety equipment (brake fluid level sensing, etc.), along with many medical applications including defibrillators, cauterizing equipment, pacemakers and medical electronics where they isolate small leakage currents.

In both technologies, the sizes are shrinking as is evidenced in the enclosed picture. However, when comparing the reed sensor over a Hall effect sensor we see several advantages:

Cost-Effective

Generally the cost of the Hall effect device is low, but it requires power and circuitry to operate. Also, its signal output is so low it often times requires amplification circuitry as well. The net result, the Hall effect sensor can be considerably more expensive than the reed sensor.

High Isolation

The reed switch has superior isolation from in-input to output and across the switch up to 10¹⁵ Ohms. This reduces leakage currents to femto amps (10¹⁵ amps) levels. On the other hand, Hall effect devices have sub-micro amp leakage levels. In medical electronic devices inserted into the human body as probes (invasive use) or pacemakers it's very important not to have any leakage current near the heart, where micro amp and sub-micro amp currents can alter the heart's key electrical activity.

Hermetically Sealed

The reed is hermetically sealed and can therefore operate in almost any environment.

Low Contact Resistance

The reed has very low on resistance typically as low as 50 milliohms, whereas the Hall effect can be in the hundreds of ohms.

Switching Power

The reed can directly switch a host of load ranging from nano volts to kilovolts, femto amps to Amps, and DC to 6 GHz. The Hall effect devices have very limited ranges of outputs

High Magnetic Sensitivity

The reed sensor has a large range of magnetic sensitivities to offer.

Easy Mounting

Reed sensors are not susceptible to E.D.I., where electrostatic discharge may often times severely damage the Hall effect device.

High Voltage

Reed sensors are capable of withstanding much higher voltages (miniature sizes are rated up to 1000 Volts). Hall effect devices need external circuitry for ratings as high as 100 Volts.

High Carry Current

The reeds are capable of switching a variety of loads, where the Hall effect sensor delivers only smaller voltages and currents.

High Shock Resistance

The reed sensor is typically tested to withstand a three-foot drop test, which is comparable to the Hall effect sensor.

Long Life Expectancy

Because the reed sensor has no wearing parts, low level loads (<5V @ 10 mA and below), will operate satisfactorily well into the billions of operations. This rivals semiconductor MTBF figures.

Wide Temperature Range

The reed sensor is unaffected by the thermal environment, and is typically operated from -50° C to +150° C with no special additions, modifications or costs. The Hall effect sensors have a limited operational range.

No external Power

Ideal for portable and battery-powered devices.

There are many very good applications of reed products. Selection of the proper reed in the proper application, often time is critical. Some reed/relay companies are excellent at designing in reeds in critical applications where quality, reliability and safety are paramount.

Comparative Table: Reed Sensors vs. Hall Effect Sensors

Specifications	Reed Sensor	Hall Effect Sensor
Input requirements	External magnet field >5 Gauss time	External magnetic field >15 gauss time
Sensing distance	Up to 40mm effectively	Up to 20mm effectively
Output requirements	None	Continuous current >10mA, depending on sensitivity
Power required all the time	No	Yes
Requirements beyond sensing device	None	Voltage regular, constant current source, hall voltage generator, small-signal amplifier, chopper stabilization, Schmitt trigger, short-circuit protection, external filter, external switch
Hysteresis	Ability to adjust to meet design requirement	Fixed usually around 75%
Detection circuit required	None	Yes, and generally needs amplification
Ability to switch loads directly	Yes, up to 2A and 1,000V, depending on the reed selection	No, requires external switching
Output switching power	Up to 1,000W, depending on switch selection	Low milliwatts
Voltage switching range	0 to 200V (1,000V available)	Requires external switch
Current switching range	0 to 3A	Requires external switch
Output sensitivity to polarity	No	Yes, critical for proper operation
Output offset voltage sensitivity	None	Yes, exacerbated by sensitivity to over-coming, temperature dependencies, and thermal stress
Chopper circuit requirements	None	Yes, helps reduce output offset voltage; requires additional external output capacitance
Frequency range	DC to 6 GHz	Switching frequency 10,000 Hz
Closed output on resistance	0.050 Ohm	>200 Ohm
Expected life switching >5A @ 10mA	> 1 billion operations	Unlimited
Capacitance across output	0.2 pF typ	100 pF typ
Input / Output isolation	10 ¹² Ohm min.	10 ¹² Ohm min
Isolation across output	10 ¹² Ohm min.	10 ⁶ Ohm min
Output dielectric strength	Up to 10kV available	<10 V typical
EDI (ESD) susceptibility	No, requires no external protection	Yes, requires external protection
Hermeticity	Yes	No
Shock	> 150g	>150 g
Vibration	> 10g	>50 g
Operating temperature	-55°C to 200°C	0 °C to 70°C, typ
Storage temperature	-55°C to 200°C	-55°C to 125°C

Reed Switches in Comparison with Mechanical Switches

Specifications	Reed Switch	Mechanical Microswitch
Sensing Distance - Touch	Up to 40mm effectively	Touch (zero distance)
Power Required all the Time	No	No
Input Requirements	External magnetic field >5 gauss min.	Mechanical Force
Hysteresis	Ability to adjust, to meet design request	Differential Travel (D.T.)
Life Expectancy: Low Level	10 ¹⁰ cycles	10 ⁶ cycles
Switching Voltage	Up to 200V (10,000V available)	250VAC
Switching Current/ Carry Current	Up to 3A/Up to 5A	Up to 25A
Switching Load Minimum	No load required ($\mu V / \mu A$)	50mW
Switching Load Maximum	Up to 100 Watts	Up to 5,000 Watts
Insulation Resistance	10 ¹⁴ Ohm	10 ⁹ Ohm
Contact Resistance	50 milliohm	100 milliohm
Noise	Almost no switching noise	Switching Noise
Overload	Very sensitive	Insensitive
Hermeticity	Yes	No
General	Galvanic isolation (air gap)	Galvanic Isolation (air gap)
Assembly	20,000 pcs	5,000 pcs

Magnets and their Specifications

Magnets are available in multiple specifications on the market. Almost all dimensions and geometries can be realized. To activate the reed switch a magnet (magnet field) is needed. The different magnet materials have either more positive or negative specifications, depending on the dimension and geometries as well as on the environment. Most preferred and used forms are cylinders, rectangles, and rings. Depending on the different requirements, magnets can be magnetized in many different ways (figure #1).

In applications where a magnet is used to activate a reed sensor/switch, the environmental temperature needs to be considered (in the application as well as in storage). High temperatures can cause irreversible damage (so-called Curie temperature) and will have heavy impact on the magnetic force and the long term stability. AlNiCo magnets are best suitable for applications up to 450°C.

Furthermore each magnet material has a different magnet force as well as a different flux density. Additionally to dimension and material, other factors exist that define the energy of a magnet. These are mounting position, environment and other magnetic field which influence the interaction between reed sensor/switch and magnet. In

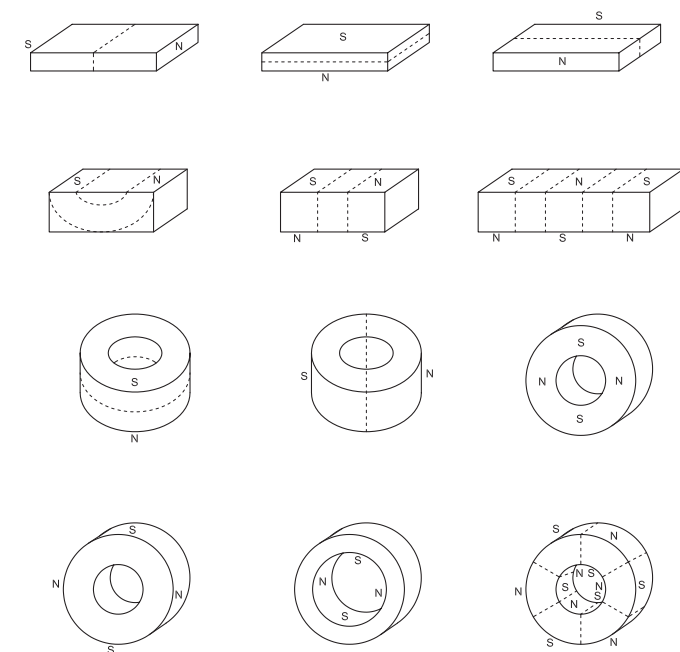

Fig. #1 An assortment of magnets are shown. Magnets can be formed and made into almost any shape.

General Information to Magnet Material

Magnets have reversible and irreversible demagnetization specifications. Be specially careful with shock, vibration, strong and close external magnetic fields as well as high temperatures. All these factors influence the magnetic force and the long term stability in different intensities. Preferably the magnet is mounted on the moving part of the application. Professional tuning of magnet and reed switch can improve the functionality of the whole sensor-magnet system.

	LOW HIGH			
Costs	Ferrite	AlNiCo	NdFeB	SmCo
Energy (WxHmax.)	Ferrite	AlNiCo	SmCo	NdFeB
Working Temperature	NdFeB	Ferrite	SmCo	AlNiCo
Corrosion - Resistant	NdFeB	SmCo	AlNiCo	Ferrite
Opposing Field - Resistant	AlNiCo	Ferrite	NdFeB	SmCo
Mechanical Strength	Ferrite	SmCo	NdFeB	AlNiCo
Temperature Coefficient	AlNiCo	SmCo	NdFeB	Ferrite

AlNiCo Features	Standard Geometric and Magnetization	
	Rectangle	Cylinder
<ul style="list-style-type: none"> Working Temperature from -250 to 450 °C Low Temperature Coefficient 		

AlNiCo – Magnets

Raw materials for AlNiCo magnets are aluminium nickel, cobalt, iron and titanium. AlNiCos are produced in a sintering - casting procedure. The hard material needs to be processed by grinding to be cost effective. Due to its specifications, the best dimension is a remarkably longer length than its diameter. In combination with reed sensors/switches we recommend a length/diameter ratio of more than 4. AlNiCo magnets have an excellent temperature stability. Cylindrical AlNiCo magnets can be used with all Standex Electronics reed sensors /switches without any problems.

AlNiCo Magnetic Values according to DIN 17410		Min.	Typ.	Max.	Units
Energy Product	(B x H) max.		35		kJ/m ³
Remanence		600		1300	mT
Coercivity	H _{cB}		45		kA/m
Coercivity	H _{cJ}		48		kA/m
Density			7.3		g/cm ³
Max. Operating Temperature				450	°C
Curie Temperature				850	°C

All details correspond to manufacturers information & magnet material

Rare – Earth Magnets (NdFeB & SmCo)

SmCo Features	Standard Geometric and Magnetization		
	Disc	Rectangle	Cylinder
<ul style="list-style-type: none"> High energy density Small size Working temperature up to 250 °C Best opposing field-resistance Available plastic bounded 			

NdFeB Features	Standard Geometric and Magnetization		
	Disc	Flat Rectangle	Ring
<ul style="list-style-type: none"> High energy density Small size Working temperature up to 180 °C Lower prices compared to SmCo Available plastic bounded 			

Rare earth magnets like SmCo and NdFeB have the highest energy density per volume and weight and also the best demagnetization resistance. Following below, we compare other magnets with the same energy:

- Hartferrit = Volumes 6 cm³
- AlNiCo = Volumes 4 cm³
- SmCo = Volumes 1 cm³
- NdFeB = Volumes 0.5 cm³

Both magnets are produced by sintering and can only be processed by grinding, due to the strength and brittle of the material. The temperature range goes up to + 250 °C. Very small magnets can be produced. Disadvantages are the high raw material prices and the limited availability of special alloys.

The supply of different geometry, size and magnetization allow many creative combination of reed sensor/switch and magnet and help to find the best functionality of the sensor – magnet system for each application.

SmCo ₅ Magnetic Values according to DIN 17410		Min.	Typ.	Max.	Units
Energy Product	(B x H) max.	150		220	kJ/ m ³
Remanence	B _r	900		1050	mT
Coercivity	H _{cb}		700		kA/m
Coercivity	H _{cj}		1500		kA/m
Density			8.3		g/cm ³
Max. Operating Temperature				250	°C
Curie Temperature				750	°C
All details correspond to manufacturers information & magnet material					

NdFeB Magnetic Values according to DIN 17410		Min.	Typ.	Max.	Units
Energy Product	(B x H) max.	200		400	kJ/ m ³
Remanence	B _r	1020		1400	mT
Coercivity	H _{cb}		800		kA/m
Coercivity	H _{cj}	955		2000	kA/m
Density			7.6		g/cm ³
Max. Operating Temperature				160	°C
Curie Temperature				330	°C
All details correspond to manufacturers information & magnet material					

Hard Ferrite – Magnets

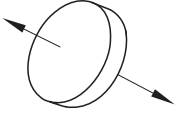
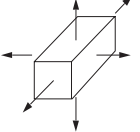
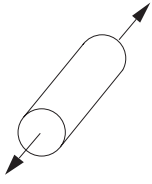
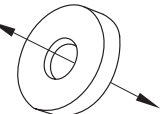





Ferrite Features	Standard Geometric and Magnetization			
	Disc	Rectangle	Cylinder	Ring
<ul style="list-style-type: none"> Cheapest magnet material Working temperature up to 300 °C Many options in form and magnetization Available plastic bounded 				

Hard ferrite magnets are produced with iron oxide and barium or strontium oxide. The raw materials are mixed together and normally pre sintered, to generate the magnetic phase. The pre sintered mixture then gets crushed. The resulting powder gets pressed together (wet or dry) either in a magnetic field (an - isotropic) or without a magnetic field (isotropic) and in the end sintered. Proceedings are only possible by grinding. Due to the low cost of the raw material, hard ferrite magnets are the cheapest magnet type out of the actual supply of

magnets. Ferrites have a very good electrical isolation effect and are hard to demagnetize even in strong external magnetic fields. Corrosion tendency is low. Preferred shapes are long and thin but also round forms are easy to produce. Disadvantages are the high breakability and the low tensile strength. The strength and brittleness of hard ferrites are similar to ceramics. Furthermore the temperature resistance is limited and they have only a low energy to volume ratio.

Ferrite Magnetic Values according to DIN 17410		Min.	Typ.	Max.	Units
Energy Product	(B x H) max.		26		kJ/ m ³
Remanence	B _r	200		410	mT
Coercivity	H _{cb}		200		kA/m
Coercivity	H _{cj}		240		kA/m
Density			4.8		g/cm ³
Max. Operating Temperature				250	°C
Curie Temperature				450	°C
All details correspond to manufacturers information & magnet material					

Handling Information for Magnets

	The strong magnetic forces of attraction can cause skin bruises. Sufficient security distances need to be kept between each magnet and all other ferromagnetic elements!
	A crash of magnets with high energy can produce splinters. Therefore always wear protection gloves and glasses!
	Grinding dust of Rare – Earth Magnets is spontaneously inflammable. Always process with water!
	Crashes of magnets can cause sparks. Handling and processing in EX – environment is therefore strictly prohibited!
	Strong magnetic fields can influence electronic and electrical devices as well as data mediums. Don't bring magnets close to peace makers, navigation instruments, diskettes, plug-in boards etc.
	For air cargo a special declaration maybe possible.
	Radioactivity as well as joining together equal poles can reduce the magnetic force.
	The highest defined working temperature must not be passed.

For all questions concerning magnets and, of course, reed products, please consult us!

Magnetization

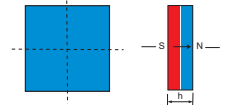
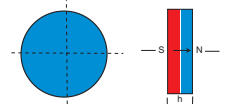
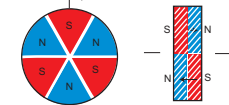
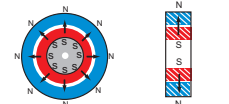
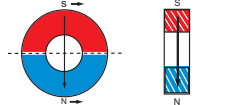
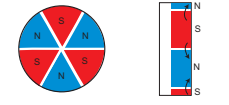
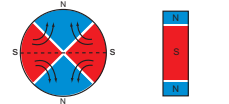
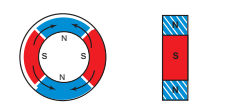
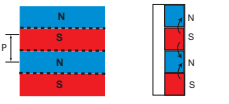
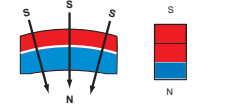
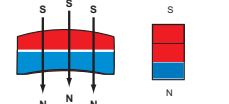
Magnetization		Applications	Arrangement
	Magnetized in height (preferred orientation)	Motors, magnetic couplings, ABS-systems, locking systems, cutter, press cylinder	Isotropic Anisotropic
	Axial magnetization	Loud-speakers, pot-magnet systems, holding systems, magnet switch, protection gas control	Isotropic Anisotropic
	Axial, sector-shaped magnetized, e.g. 6-pole	Synchronized motors, magnetic couplings, brakes, hall sensors, hard-disc-drive	Isotropic Anisotropic
	Radial magnetization	Lifting magnets, holding systems, magnet bearings	Isotropic Anisotropic 1)
	Diametric magnetization	Synchronous motors, pumps	Isotropic Anisotropic 1)
	Magnetized on sector-shaped surface, e.g. 6-pole magnet	Magnetic separation, brakes, holding systems, hall sensors, hard-disc-drive	Isotropic Anisotropic Pole-oriented
	Multi-pole in circumference magnetized e.g. 4-pole	Dynamos, engines, magnetic couplings, brakes, hall sensors, tachometer	Isotropic Pole-oriented
	Two- or multi pole magnetized at inside -ø, e.g. 4-polig	Magnetic couplings, brakes, motors, hall sensors, tachometer	Isotropic Anisotropic
	Magnetized on lamellar-shaped surface P = pole pitch	Holding systems, protection gas control. hall sensors, brakes	isotropic anisotropic pole-oriented
	Radial magnetization	Motors, magnetic couplings	Isotropic Anisotropic
	Diametric magnetization	Motors, magnetic couplings	Isotropic Anisotropic

Notes

Handling and Load Precautions when using Reed Switches in various Sensor and Relay Applications

Many users of Reed Switches for sensor and reed relay applications try to make the sensors and or relays themselves internally. Often however, they do not observe some basic precautions and preventive measures to insure reliable operation of the switch. Below we try to cover the key areas that users and manufacturers must observe.

Reed Switch modifications can be very dangerous to the Reed Switch if not done properly. Primarily, this is because the reed lead is large by comparison to the glass seal. Here a balance is achieved in Reed Switch sensitivity and mechanical strength. If the lead of the Reed Switch was much smaller than the glass, seal stress and glass breakage would not be an issue. However, to achieve the sensitivity and power requirements in the Reed Switch, a larger lead blade is necessary. With that in mind, it cannot be emphasized enough, any forming or cutting of the Reed Switch leads must be done with extreme caution. Any cracking or chipping of the glass are signs that damage has occurred. Internal damage can occur with no visible signs on the seal. In these instances, seal stress has occurred, leaving a torsional, lateral, or translational stress in the seal. This produces a net force on the contact area that can affect the operate characteristics (Pull-In and Drop-Out), contact resistance, and life characteristics.

Most Reed Switch suppliers can perform value added cutting and shaping of the leads in a stress free environment using proper tooling and fixtures. Often times this is the most economical approach for users, although it may not seem so at the time.

Many times the user will often choose to make their own modifications, and only after manufacturing and quality problems with the product, do they go back and choose the approach of letting the Reed Switch manufacturer perform the value added requirements. Below, in figure #1 and #2, is the proper approach for cutting and/or bending the Reed Switch. The effect on the Pull-In and Drop-Out characteristics of cutting and bending the Reed

Switch will be explained later in more detail.

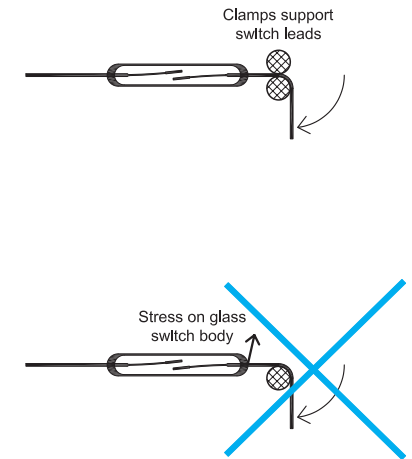

Fig. #1 Presentation of the proper and improper way of bending a Reed Switch. Supporting the switch lead while bending is a must.

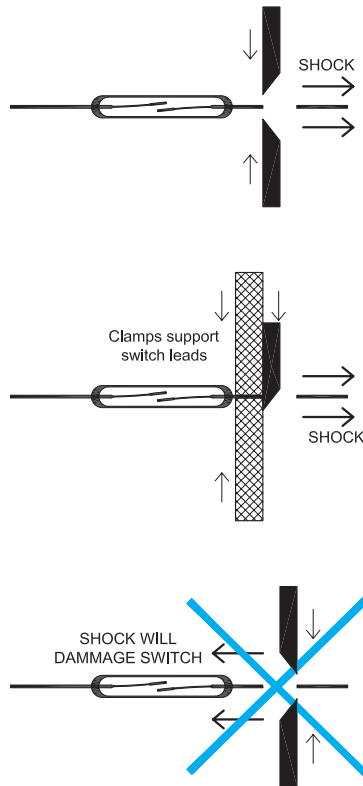

Fig. #2 Properly supported the switch lead while cutting is required, otherwise damage can occur to the Reed Switch.

Soldering and Welding

Many times soldering or welding of the Reed Switch is required. Reed Switches are usually plated with a suitable solderable plating. Welding is also easily carried out on the nickel/iron leads of the Reed Switch as well. However, in both processes, if not done properly, stress, cracking, chipping or breaking of the Reed Switch can occur. When soldering or welding, the farther one is away from the glass seal the better. Many times, this may not be possible. Welding can be the most dangerous if one is welding very close to the seal. Here a heat front of up

to 1,000 °C can conduct its way to the seal.

Since it arrives on one end of the seal first, the other end of the seal may be at 20 °C. This causes a dramatic thermal gradient to exist across the seal which can disrupt the seal in many ways, all of which, will give rise to faulty Reed Switch operation. See figure #3.

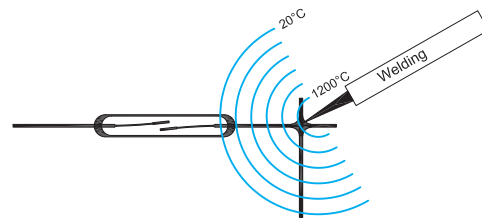

Fig. #3 Soldering and welding can generate a heat front to the glass to metal seal of the Reed Switch causing potential damage.

Soldering, in a similar manner, close to the seal can have the same effect to a lesser extent because of the lower solder temperatures involved (200°C to 300°C).

Two ways to improve the likelihood of success are by heat sinking the lead of the Reed Switch (figure #4) or by preheating the Reed Switch and/or assembly.

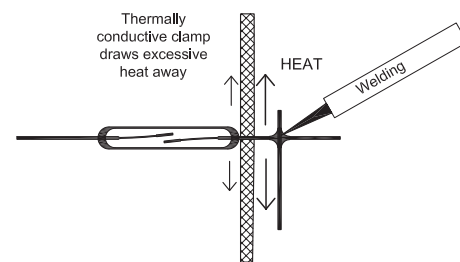

Fig. #4 Use of Heat Sinking or preheating Reed Switches for soldering or welding can prevent heat stress damage.

Most commercial wave soldering machines have a pre-heating section before the PCB or assembly is immersed into the solder wave. Here the thermal shock is reduced by the existing higher ambient temperature preexisting before the solder wave, thereby reducing the thermal gradient to the reed switch seal.

Printed Circuit Board (PCB)

Mounting Reed products mounted on PCBs can sometimes be a problem. If the PCBs have a flex to them after wave soldering, removing this flex may be required when mounting the board to a fixed position. When the flex is removed, the hole distance, where a Reed Switch for instance may be mounted, can change by a small amount. If there is no provision in the mounting to take this small movement into consideration, the Reed switch seal will end up absorbing the movement, which leads to seal stress, glass chipping or cracking. Care should be taken in this area, particularly when very thin PCBs are used and flexing or board distortion is common.

Using Ultrasonics

Another approach to making a connection to a Reed Switch is ultrasonic welding. Reed Switch Sensors and Reed Relays may also be sealed in plastic housings where the sealing process uses ultrasonic welding. In addition, cleaning stations use ultrasonic welding. In all these areas the Reed Switch can be damaged by the ultrasonic frequency. Ultrasonic frequencies range from 10kHz to 250kHz, and in some cases even higher. One does not only have to be concerned with the resonant frequency of the Reed Switch and its harmonics, but also of the resonant frequency of the assembly in which the Reed Switch resides. Given the right frequency and the exact conditions severe damage can occur to the contacts. If using ultrasonics in any of the above conditions, be very cautious and perform exhaustive testing to insure there is no interaction or reaction with the Reed Switch.

Dropping Reed Switch Products

Dropping the Reed Switch, a Reed Sensor, or a Reed Relay on a hard object, typically on the floor of a manufacturing facility, can induce a damaging shock to the Reed Switch. Shocks above 200 Gs should be avoided at all costs. (See Figure #45.) Dropping any of the above on a hard floor from 20 cm or more (greater than one foot) can and will often destroy a Reed Switch where G forces greater than 1000 Gs are not uncommon. Not only can the glass seal crack under these circumstances, but the reed blades may be dramatically altered. Here the gaps may have been drastically increased or the gaps may be closed, due to these high G forces. Simple precautions of placing rubber mats at assembly stations can eliminate these problems. Also, instructing operators that if a reed product is dropped it can not be used until it is re-tested.

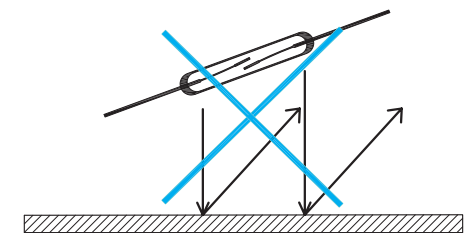

Fig. #5 Dropping the Reed Switch on a hard surface can induce several 100 Gs to the contacts many times altering the switch characteristics.

Load Switching and Contact Protection

Encapsulating Reed Switch Products

Further damage can occur to a Reed Switch when one attempts to package the Reed Switch by sealing, potting, or encapsulating. Whether this is done by a one or two part epoxy, thermoplastic encapsulation, thermoset encapsulation, or other approaches, damage to the glass seal can occur. Without any buffer, the encapsulants crack, chip or stress the glass seal. Using a buffer compound between the Reed Switch and the encapsulant that absorbs any induced stress is a good approach to eliminate this problem. Another approach would be to match the linear coefficient of thermal expansion with that of the Reed Switch, thereby reducing stress as the temperature fluctuates. However, keep in mind, this approach does not take into consideration the shrinkage that occurs in most epoxies and encapsulants during the curing stage.

Sometimes a combination of both approaches may be the best way to seal a product with a Reed Switch.

Temperature Effects and Mechanical Shock

Temperature cycling and temperature shock if naturally occurring in a Reed Switch application must be taken into consideration. Again, temperature changes creating movement with various materials due to their linear coefficients of thermal expansion will induce stress to the Reed Switch if not properly dealt with. All our Reed Sensors and Reed Relays have been designed to handle temperature changes and mechanical shock. Through rigorous qualification testing by exposure to temperature cycling, temperature shock and mechanical shock, potential design defects have been eliminated from our products.

The Reed Switch contact rating is dependent on the switch size, gap size or ampere turn rating, contact material and atmosphere within the glass capsule. To receive the maximum life for a given load some precautions may be necessary.

Because a Reed Switch is a mechanical device and has moving parts, there are circumstances where life will be shortened due primarily to contact wear. Switching no load or loads where the voltage is less than 5 Volts @ 10 mA or less, the contacts undergo little or no wear. Here life times in excess of billions of operations are expected and realized. In the 10 Volt range, higher contact wear will take place. The amount of wear is dependent upon the current switched. Generally speaking, switching 10 Volts @ 10 mA, life times of 50 million to 200 million operations can be expected. If one is looking for more life under these circumstances and you can not eliminate the actual switching of the load, mercury wetted contacts may be the correct solution. Here the contacts actually have a small amount of mercury on them so that no net metal is ever transferred from contact to contact. Life for most 'hot' switching loads using mercury wetted contacts will also be in the billions of operations even when switching 100's of Volts at 10's of mA.

Switching pure DC loads is always advised. All the data shown in our life test section, has been taken under this condition. Avoid loads with a leading or trailing power factors.

The quick disconnection creates a high induction voltage, which will result in arcing. This creates burns on the contact surface.

When the contacts see a net overall capacitive load, an inrush of current will occur when closing the contacts. Contact damage and even sticking will occur depending up the total capacitance, voltage present and series resistance.

Tungsten filament lamps, a very popular switching load

for Reed Switches particularly in automotive, have inrush currents due to their cold filaments. Once the light is on the resistance in the filament rises rapidly reducing the current flow. Typically current surges in the order of 10 to 20 times the steady state current can be expected. Knowing the cold filament resistance is important to determine the size of the inrush current. Adding some series resistance to the same circuit can have a dramatic improvement on the life of the switch.

Capacitive and Inductive Loads

Stray capacitance may be present, to some degree, when switching any voltage and current. When closing and switching a given voltage and current, the first 50 nanoSeconds are the most important (figure #6). This is where the exact amount of arcing will occur. If there is a significant amount (depends on the amount of voltage switched), of stray capacitance in the switching circuit, a much greater arc may occur and thereby reduce life. When switching any sizable voltage, it is always a smart idea to place a fast current probe in the circuit to see exactly what one is switching in the first 50 nanoSeconds. Generally speaking, when switching voltages over 50 Volts, 50 picoFarads or more can be very significant to the expected life times. If the Reed Switch is operated remotely with a long cable connection, that cable can act like a long distributed capacitance. Shields and other potentially capacitive components can also lend their capacitance to high inrush currents.

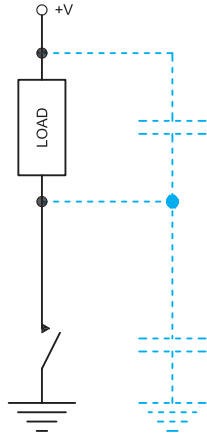

Fig. #6 Surprisingly large inrush currents can be generated across the contact when stray capacitance is charged to compliance voltages. Contact life may be dramatically shortened.

When line voltages are present in or near sensitive circuits, be cautious. Those voltages can be coupled into the circuit creating havoc with your life requirements. Typically, a faulty Reed Switch is blamed for this reduced life, when in actuality, it is a product of unforeseen conditions in the circuit.

Protection Circuitry

Under above conditions, protective circuitry can be added which will minimize the metal transfer at the time of the transitions, but not eliminate it. Circuits shown in figure #7 are very typical. The capacitance can be only a few pF attributed to stray capacitances or actual capacitive components in the mf range. Capacitors in an electronic circuit store charge. By their nature they like to give up their entire charge as quickly as possible. With no resistance or impedance to the flow of the current, that is exactly what will occur.

Inrush currents are to be avoided or minimized when closing the contacts of a Reed Switch. If your circuit allows series resistance to be added directly in line with the Reed Switch, that is generally the best choice. The higher the resistance the better as shown in Figure #7. Using an inductor or adding inductance in the circuit can be effective as well. Inductors initially impede the flow of current, thereby reducing inrush currents. Here a careful balance must be calculated such that too much inductance is not added, thwarting its effect and creating another problem when the contacts open.

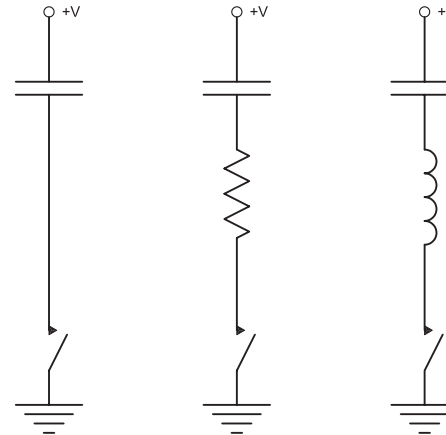

Switching inductive loads such as relays, solenoids, coil driven counters, small motors or inductive circuits will all require protective circuitry to lengthen the life of the reed contacts (see figure 8).

Fig. #7 Switching capacitance directly will damage the contacts rapidly with high inrush currents. Adding a resistor or an inductor will reduce the inrush current and reduce the contact wear.

A Comparison of the measured Magnetic Field Strength using Ampere-Turns (AT) and Millitesla (mT)

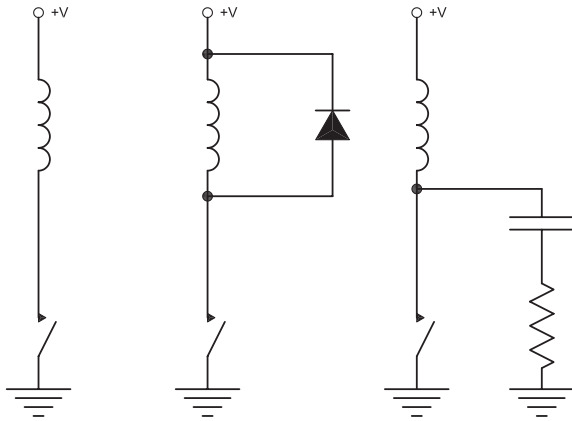

Fig. #8 Abruptly opening a circuit with an inductor can produce a very large back voltage. Adding a diode in parallel with the coil will dramatically reduce this voltage. An RC network across the contact will also help.

Inrush Current Loads

Lamp loads can also produce high inrush currents when they are initially switched on. Here typically tungsten filaments are used in small bulbs which will have inrush currents as high as 10 times their normal operating current when initially switched on. See figure #9. Adding resistance in series with the lamp can dramatically reduce the inrush current and play a major role in extending the life of the Reed Switch.

Another approach is to add a parallel resistor across the contacts as shown in Figure #9. In this case, a small current always flows through the filament keeping it hot and its resistance high. This current flow is balanced such that the filament is not 'glowing'. Now when the Reed Switch is activated, the current switched is close to its steady state current.

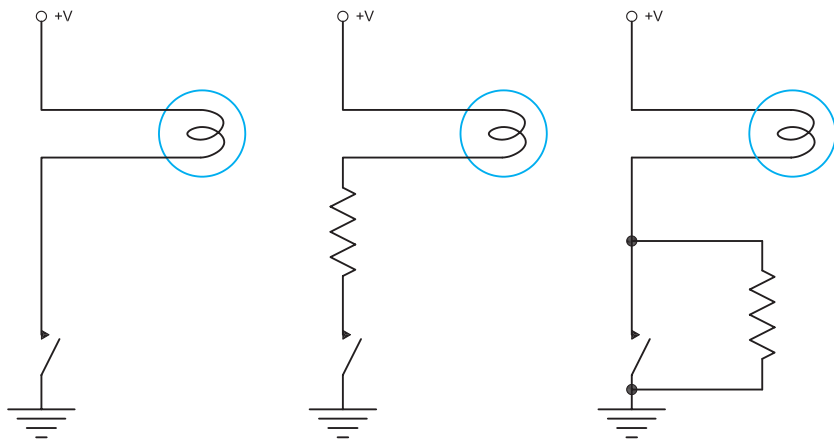

Fig. #9 Lamps when first turned on have a high inrush current because of their cold filament. Adding series resistance will reduce the inrush. Having a resistor in parallel with the contacts will allow a trickle current to flow, heating the lamp filament below it. Then when the contacts close the filament is hot and does not draw an inrush current.

With the advent of the Reed Switch, developed by Bell Labs in the 1930s, it was convenient to measure its operate characteristics using the units of ampere turns. Since the Reed Switch is cylindrical it is easy to make the measurement of its closure, release and contact resistance using a coil with a given geometry, wire size and number of turns. It is easy to conventionalize this approach as long as other users, internal or external, find no problem using ampere-turns (AT) as their unit of measure.

However, a real problem arises when one finds that no convention has ever been adopted in the Reed Switches' long history; in fact, most manufacturers of Reed Switches have their own standard. Therefore, companies who purchase their Reed Switches for making Reed Relays, Reed Sensors or other reed products find they have to deal with an assortment of AT standards. No true standard is offered to customers who use Reed Relays, Reed Sensors, etc.

Users find themselves selecting reed products with no idea how to categorize or select them for their own applications. This results in much time lost and frustration in trying to select the proper product. Often times, many thousands of dollars may be lost through high production failures or production line shut down, before determining the correct Reed Switch sensitivity selection.

What we plan to present here is a standard that manufacturers of Reed Switches, manufacturers of reed products, and users of reed products can all use. We will present a simple way to bridge the approach of measuring the magnetic field strength of a Reed Switch from the Reed Switch manufacturer/reed product manufacturer to the reed user's application.

Before we present this approach, we need to review a few very important points that generally affect Reed Switch applications:

1. When a Reed Switch is initially measured, it is made with its given overall length. This length is established by the manufacturer to offer the users the most flexibility for short and long length design requirements. As one cuts the Reed Switch to a given size for a given application the AT for that switch will change. If now measured in the same coil to a given cut length, the AT will be different. If significant lead length is cut off the AT change can be dramatic. This occurs because the reed blades are ferromagnetic and the more magnetic material present the more efficient the magnetic field strength. Cutting away the magnetic material will reduce the magnetic field strength; thereby, reducing the magnetic sensitivity of the Reed Switch. Some companies for a given special requirement will supply the AT difference in their specification for a given cut length. However, if the user cannot measure his application in the standard test coil used by the Reed Switch supplier because his application does not 'fit' into it, which is most times the case, it becomes impossible to directly correlate between the two companies when using AT only.
2. Reed Switches that are not cut, but bent into a new configuration, will often undergo an AT change as well. Here, whenever the magnetic path is altered, the magnetic field strength may change depending upon the new given configuration.
3. When a Reed Switch is bent into a new configuration with or without cutting the lead length, the AT may be additionally altered by improperly bending the Reed Switch. All Reed Switches have some susceptibility to any stress placed on either end of its glass to metal seal. Some switches are more susceptible than others. In any case, a stress to the seal can alter the mechanical operation and thereby alter its AT. The Reed Switch gap generally averages less than 25 microns (0.001"). Any small mechanical change produced by either a torsional, rotational or linear force can give rise to an

AT or contact resistance change. The contact gap, contact design, blade overlap, lead material, lead material hardness, lead material length and thickness, seal strength, seal length, glass length and measurement approach, will all influence the AT of a Reed Switch.

Since the user in most cases can not measure his magnetic field requirements in AT, the easiest way and more accepted way is to measure the requirement in Gauss or Millitesla (mT). Here 10 Gauss is equal to 1 mT making the in-interchange between the two units an easy task. More generally accepted outside the Reed Switch and reed product manufacturing arena is the use of Gauss and Tesla or Millitesla (mT).

Bridging Ampere-Turns (AT) to Millitesla (mT)

The rest of this discussion will be to bridge the gap between ampere-turns (AT) to Millitesla (mT). The lower the AT or mT rating of a Reed Switch the lower the magnetic field strength required to close the Reed Switch. To accomplish this bridge, we have chosen to use its internal KMS standard coils as our AT standard; and bridging to mT by using a standard AlNiCo 5 magnet with a given length and mT rating. We found the easiest way to make this bridging of units was to do the following:

1. First measure a group of Reed Switches in our standard KMS coil and record the operate AT.
2. Using a linear micrometer table, with a 1240 mT AlNiCo 5 magnet measuring 4 mm by 19 mm in length, mounted at its axis origin, the magnetic field strength was measured (in mT) at regular mm intervals along the linear axis. See Figure 1. Here it is very important not to have any ferromagnetic material as part of the test setup or anywhere near the testing..
3. Using the same setup as in step two, we now measure the operate point in mm of the previously

measured Reed Switches used in step one.

4. The mm distance of the closure points is now mapped with the mT field strength taken in step two

The graphs that follow were produced in exactly this above described manner. Keep in mind this data is taken for the full length, uncut Reed Switch. However, this data can be used for various cut lengths by using another graph, which presents the percent of change for a given cut length. This percentage change graph is shown for various AT switches and the percentage changes not covered can be extrapolated using the graph data.

Using the graphs in figure 5ff, we can directly convert to mT.

An example of using this approach with the included graphs is the following:

1. Your application requires you to use our KSK-1A85 Reed Switch, and you need to use only its cut length of 30 mm.
2. You plan to have the Reed Switch close 15 mm away from the magnet you have chosen.
3. You are capable of measuring your magnetic field strength at this distance with a standard gaussmeter, and find you have a 2.2 mT field 15 mm from your magnet.
4. You next look at figure 7. where the AT and mT graphs presents the comparison you need for the KSK-1A85. But since you are cutting the Reed Switch to 30 mm you need to determine the percent increase expected. For a 20 AT Reed Switch being cut to 30 mm the percent increase is approximately 30% or 6 AT change (see Figure 3). This brings the AT of the switch up to 26 AT. Now, looking at Figure 3 you see 26 AT corresponds to about 1.7 mT.

5. Here the original 20 AT switch will close well under the field of 2.2 mT giving you plenty of margin. In this way, depending upon your tolerances, you can directly select the AT range you require.

field strength at a certain point. Whereas a Reed Switch absorbs the magnetic field lines of its entire length. Therefore this approach can only be used for a rough approximation but, will enable your engineers to make a preselection of the Reed Switch easily, quickly and cost effectively for your application. Following this, we would be able to help you with the precision adjustment.

Please be aware, that a Hall probe only measures the

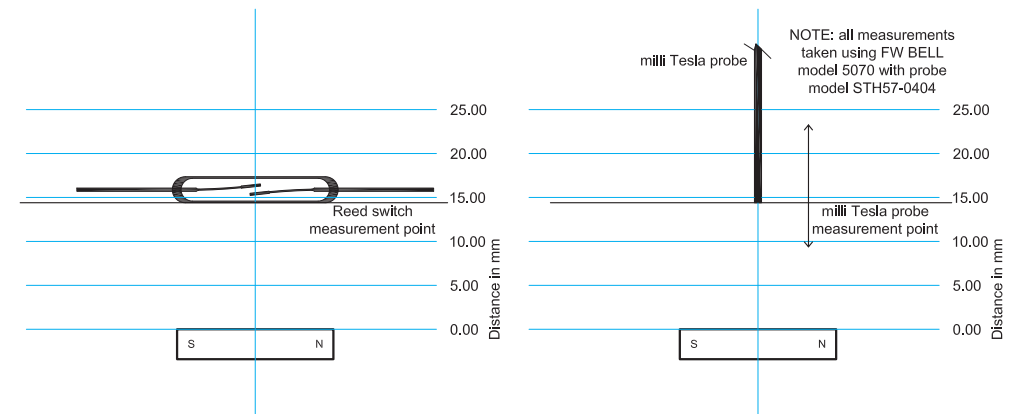

Fig. #1 Presentation of the equipment and test layout in which the magnetic data was taken using a linear micrometer.

The following graphs show the AT change for various cut lengths of Reed Switches.

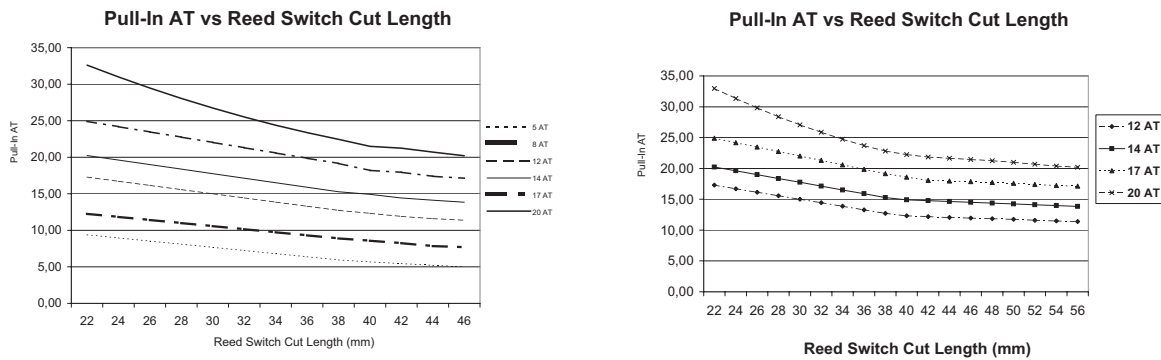

Fig. #2 Presentation of the operate AT change for various cut lengths for a given operate AT.

Fig. #3 Presentation of the operate AT change for various cut lengths for a given operate AT.

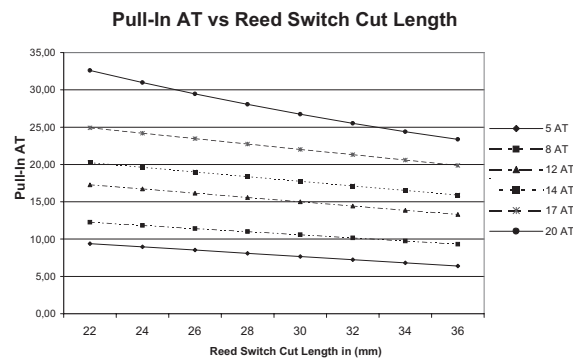

Fig. #4 Presentation of the operate AT change for various cut lengths for a given operate AT.

We have also supplied graphs showing the AT operate point versus mm distance so that a gaussmeter is not necessary. Just using these enclosed graphs will allow you to make the correct selection assuming you are using a similar magnet as was used in our data selection.

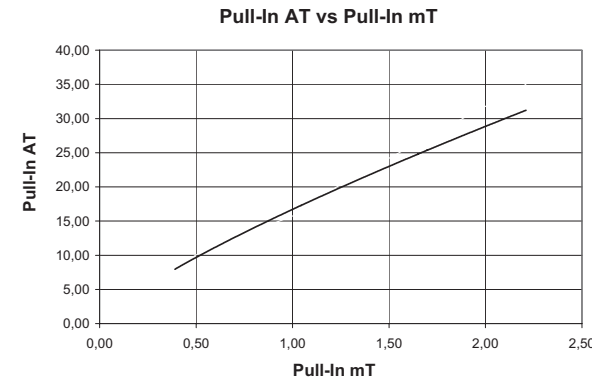

Fig. #5 The Pull-In AT is presented with its corresponding mT Pull-In level.

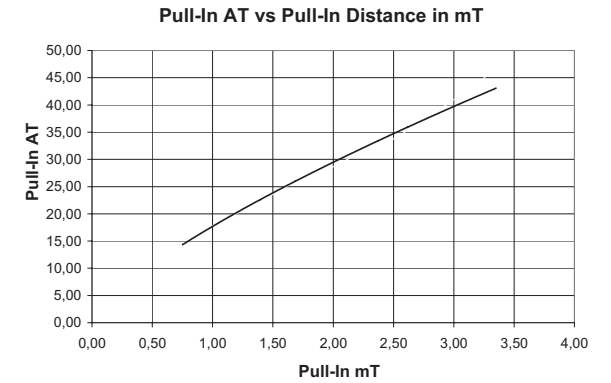

Fig. #7 The Pull-In AT is presented with its corresponding mT Pull-In level.

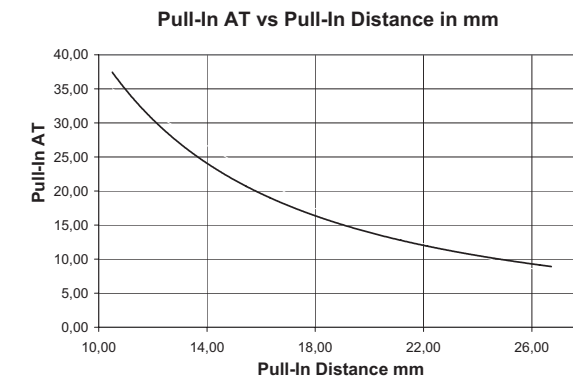

Fig. #6 The Pull-In AT is presented with its corresponding Pull-In distance from the magnet, and is measured in mm.

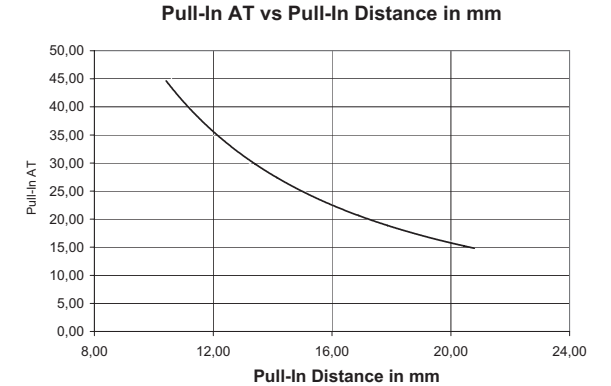

Fig. #8 The Pull-In AT is presented with its corresponding Pull-In distance from the magnet, and is measured in mm.

Reed Switch and Reed Sensor Applications

Pull-In AT vs Pull-In mT

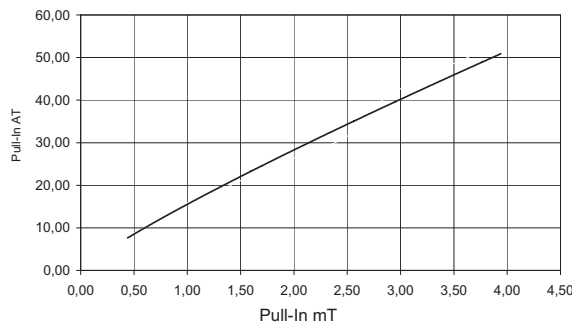

Fig. #9 The Pull-In AT is presented with its corresponding mT Pull-In level.

Pull-In AT vs Pull-In Distance in mm

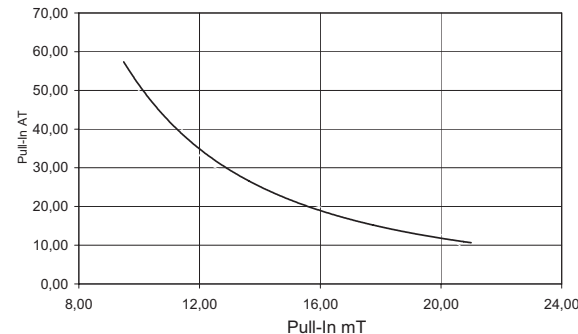

Fig #10 The Pull-In AT is presented with its corresponding Pull-In distance from the magnet, and is measured in mm.

Introduction

Reading the previous sections on the Reed Switch basics, key parameters, and operational characteristics before delving into this section will give one a better background and more insight into developing requirements for your own applications.

Without question, the Reed Switches' hermeticity lends itself to more switching applications than any other switching device. Its ability to be used as a complete sensing component by itself or the ease of packaging it into special sensing requirements is done without any complicated process or high tooling costs.

There are so many existing and potential applications for Reed Sensors that it would be impossible to discuss them all here. We will however, cover some of the basic applications which we hope, will give insight and help to your application. Once you review this section and some of the sensor specifications offered in this book, please feel free to call our applications department, where qualified engineers will be able to answer questions pertaining to your application. Free samples are always available as well.

Obviously if your application requires one of our standard sensors from our catalog, that is clearly the best approach and the quickest solution to satisfying your design requirement. However, more than half of our shipped sensors are from special requirements. Since many sensing requirements are unique, working with customers on their special applications is expected.

Using the Reed Switch by itself can seem like the simplest approach. However, without proper consideration and precaution it could become disastrous. If you decide to go this route, be sure to read our precautions section. Most important to keep in mind, the Reed Switch is a glass capsule and is susceptible to breakage. Observing this, and properly mounting the switch in a stress free environment, will prove to be a winning combination. If you do have failures or erratic operation, please discuss your

problem with our applications engineering. Many times we have taken over the application and manufactured the entire sensor thereby producing a fault free sensor. In the end, it would have been less expensive having us design and manufacture the entire sensor from the beginning. Keeping this in mind, we really are open to working with you on your application in either manner.

Reed Switch Selection

Initially the most important step is the proper selection of the correct Reed Switch for a given application. If the sensor is simply switching the gate of a transistor or digital gate any Reed Switch will handle that requirement. The question then becomes one of size and cost. Looking through our Reed Switch selection chart will help you arrive at the best choice. If you are switching a load, 'hot' switching a voltage at some current level, care must be taken to select the proper wattage Reed Switch with the corresponding required voltage and current level. Sensors requiring long life times (10's of millions of operations) will need special attention to the load you are switching. If you are switching 5 Volts @10 mA or less you will not have a life problem; above this level care must be taken. Talking with our applications engineers and reviewing our life testing section will be helpful.

Reed Sensor Packaging

Usually packaging is the safest approach when developing a Reed Sensor. Carefully protecting the glass to metal seal from potential damage or stress will result in a fault free application. When packaging the Reed Switch, even when it 'looks' fine, stress may have been induced through bending, cutting, soldering, welding, potting, or encapsulating the Reed Switch, with erratic behavior resulting. Packaging the Reed Switch without inducing any stress is critical to proper operation and long life, whether it is packaged by the user or by the Reed Switch Sensor manufacturer. Collaboration on the application, between the user and the Sensor manufacturer must be carried out in a detailed fashion.

Using our Reed Switch Sensor selector guide will give the user some ideas as to packaging styles and sizes. Special packages with specific connectors or connections are very much a norm. So do not hesitate, to offer your special packaging requirement. Our special packages are far too numerous to show in our Data Book. When determining the closure and opening distance care must be taken to include the distance within the package as part of the sensing distance. Standard packages offered by Standex Electronics will take this distance into consideration in the design. However, on special packages, keep this distance in mind because it does affect sensitivity.

Plastic packages are easiest to tool and are the least expensive. However, if a rugged enclosure is required, use of a non-ferromagnetic material may be the best approach. Be careful not to include any nickel, iron, or cobalt in the package. They will shunt the magnetic field.

Lead lengths and connectors are wide open with hundreds of possibilities for all potential requirements.

Reed Sensor Mounting

Mounting a Reed Sensor is generally quite open with a multitude of options. However, care must be taken not to mount the sensor on any ferro-magnetic material or be within its influence. Keep in mind, magnetic flux lines prefer to travel in ferromagnetic material, which in effect, will have a shunting effect on the magnetic field.

We have shown cases where this effect can be used for positive results in some applications in our operational section, but one must give consideration to magnetic materials in the vicinity of the application. Also, any magnetic components that are also in the vicinity of an application, such as inductors, transformers, toroids, etc. must be given consideration to their influence in the magnetic sensing circuit. Our Reed Sensors come with an assortment of ways in which to be mounted. Many have simple slots for screw hole mounting; some have doubleback sticky tape; some simply screw into panels;

others have pins for PCB through hole mounting; others have surface mount 'J' or 'gull' leads for mounting on SMT boards. Variations of the above are available as well, to meet all your application mounting possibilities.

Reed Switch Electrical Connections

All our Reed Sensors are manufactured with an assortment of ways in which to be electrically connected. Most of the popular ways are PCB mount, leads of varying length for soldering, leads with connectors and surface mount soldering. Some lead wires will have an array of terminals available as options for making the electrical connection. Most of our series offer terminals on the leads for quick solderless connections. Surface mount soldering is becoming increasingly popular. Our MK1, MK15, MK16, and MK17 were all designed with that in mind.

Reed Switch Sensing Applications As stated, the list for different sensing applications is endless. We will make an attempt at presenting some of the more common sensing applications, which we hope will nurture ideas that may offer solutions to your sensing application. Keep in mind, no external power is required in a Reed Sensor application. The Reed Switch in most cases, once closed will switch the load you require.

Automotive & Transportation Market Applications

Standex Electronics dynamic capabilities and solutions provide reed switches, relays, and sensors, magnetics, and fluid level sensing products throughout the transportation industry. Think of anything that turns on/off, opens/closes, requires power transfer, lighting, starting, measuring, or detecting – and we can play a role within that application.

From read outs on the dashboard to measurement of coolant, brake, windshield, water in fuel, tire pressure, and emissions – our components perform within vital processes within automobiles, heavy-duty trucks, recreational vehicles, airplanes, trains, motorcycles, E-Cars, E-Bikes, boats, and more.

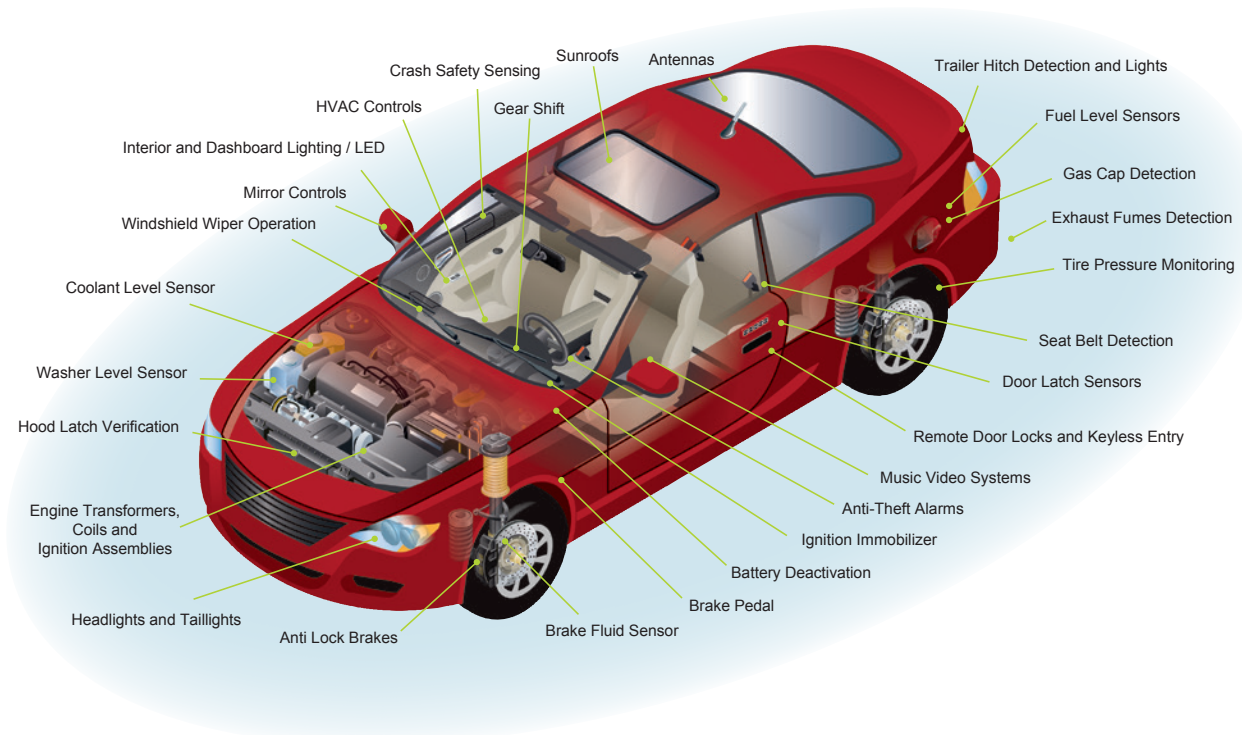

Liquid Level Detection

More and more level sensing of brake fluid, window washer fluid, and water cooling fluids are controlled by Reed Sensors. A float, with a magnet mounted in it, is generally placed in the container. The Reed Switch is placed either inside or under the container for float detection.

In the past, automotive manufacturers used the Reed Switch in the brake fluid application in the following manner: when the container is full the float opens the Reed Switch. When the liquid level drops, the float goes down and activates the Reed Switch. A lamp is then activated on the dashboard. Nowadays, automotive manufacturers use the Reed Switch in reverse order. When the container is full, the float with the magnet, actuates and closes the Reed Switch. When the level of the float drops, the Reed Switch opens. The change in monitoring the opening instead of the closure has the advantage that a malfunction of the switch can be detected much easier.

If the on-board computer on the automobile can electrically detect a level sensor, then an advanced level sensor can be used. This sensor has more electronic components than a Reed Switch. It is made with a PC board on which a resistor is mounted in series that protects the Reed Switch, and a second resistor is mounted in parallel so that the computer detects that the sensor is connected and in place.

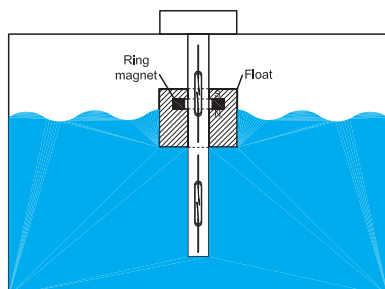

Liquid level sensor applications range from one switch to detect a high or low, to arrays of many to accurately monitor fluid levels.

Brake Fluid Detection

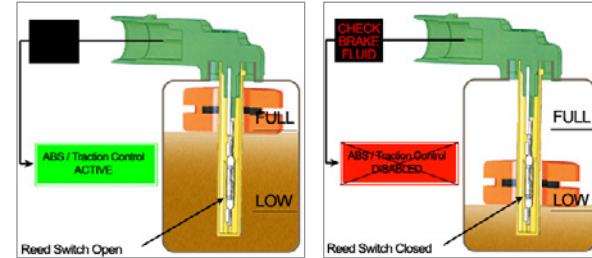

Convertible Roof Position Sensor

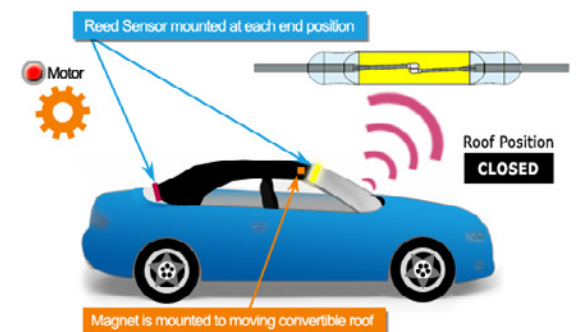
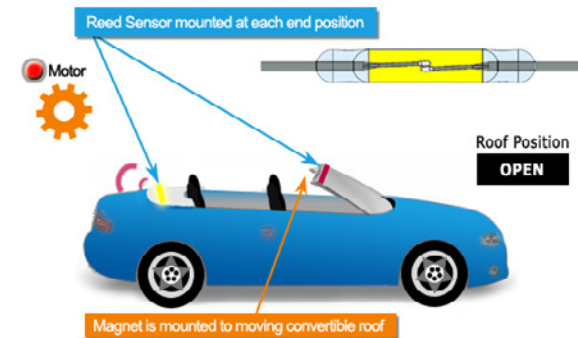

Battery Deactivation Controlled by a Reed Sensor

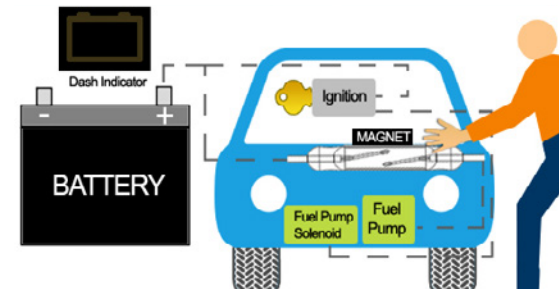
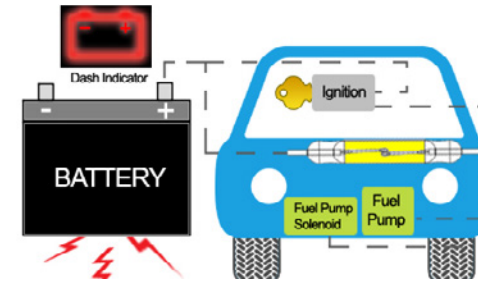

Brake Pedal Position

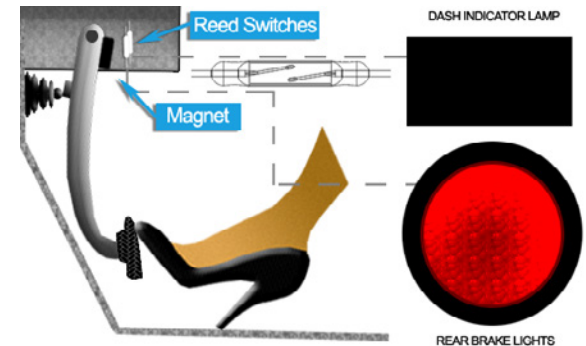
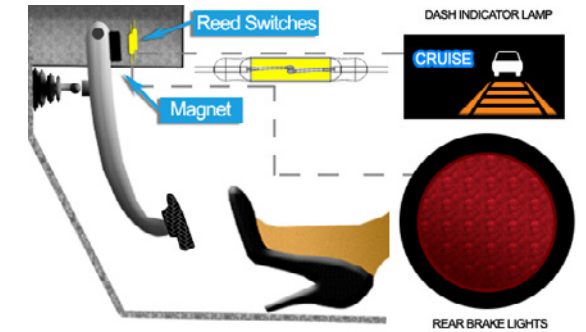

Marine and Boat Applications

Similar to automotive applications, Reed Sensors are used in marine and boat applications for level sensing and position detection.

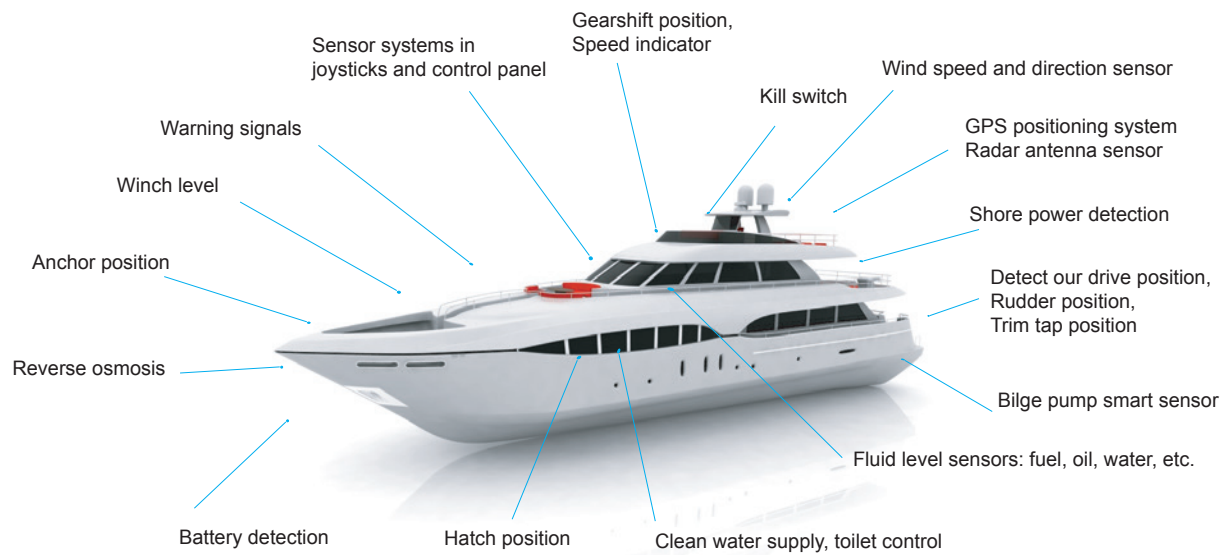

Smart Bilge Pump Sensor

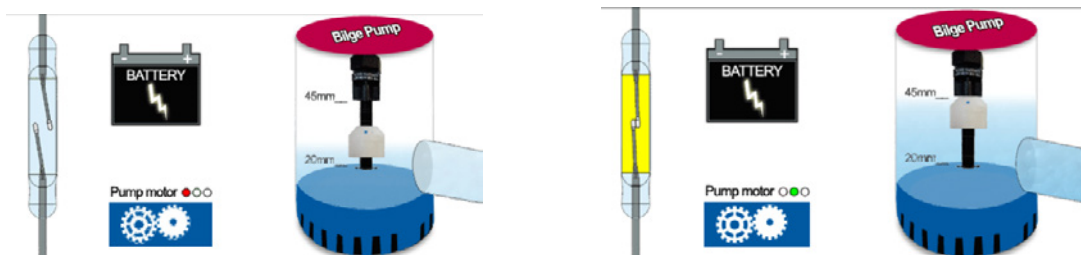

Smart Home Applications

Household appliances and electronics feature much higher efficiency and are now being designed in conjunction with smart metering devices. Detecting door position, and monitoring fluid levels are just a few examples of how reed switch sensors are making their way into household appliances.



Dishwasher Spray Arm Detection

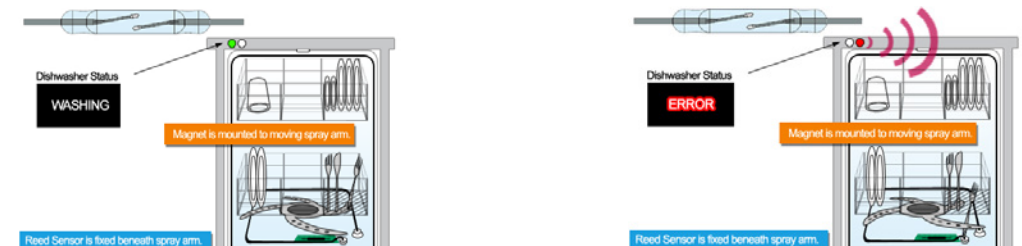

Security Control for Appliance Door Detection

The white industry of refrigerators, freezers, microwave ovens, stoves, etc. requires safety elements that detect the status (open/closed) of the appliance doors. These door sensors are designed in many sizes and shapes depending upon the specific application. Many are specifi-

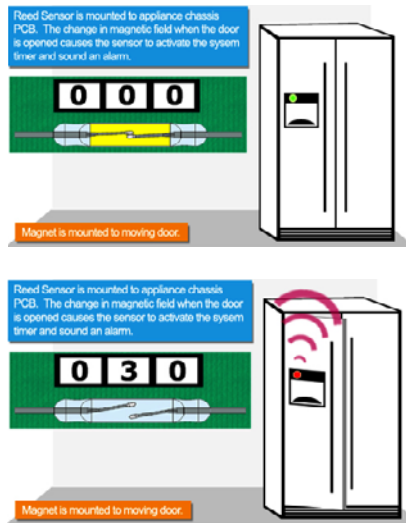

cally designed with special tooling. Generally, both a Reed Switch and a magnet are used, and in many cases, added circuitry is built into a PCB for smart sensing. If the sensor does not activate after a specified period of time, an alarm will sound, alerting one that the door is ajar. In the case of a freezer, several hundred dollars in frozen meats and other foods can be saved from spoilage if an open door is detected. The Reed Sensor is usually mounted in the chassis of the appliance and the permanent magnet is placed in the doorframe. Thus, when the door is closed, the magnet's position is above or parallel to the sensor. When someone opens the door, the circuit is broken.

Water Flow Sensor

In this application, the sensor recognizes the movement of water. The Reed Switch, in going from an open to a closed state, produces a fast response to the initiation of water flow; in turn, an action sequence is initiated.

Applications such as electric water heaters, air conditioners, etc. represent some examples. A baffle plate with a magnet mounted to it is used in the water flow line. When water begins to flow, the baffle plate moves parallel to the water flow. A Reed Switch is strategically positioned to pick up, or sense, this movement, and once the magnetic field is sensed, the Reed Switch closes. In the case of a water heater, it instantly detects the water flow, and in turn triggers the heating element to be turned on. The alternative method of detecting the temperature change when cold water is added into the tank can take

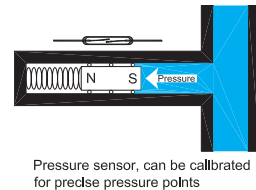

a much longer time for detection, resulting in the loss of valuable heating time, particularly when high water usage is involved

Measuring the Quantity of a Liquid or Gas

Water or fluid flow can be easily measured by mounting a propeller just outside the water pipe and connecting it underneath the plastic casing of the meter. The water flows through the pipe and spins the propeller. A mag-

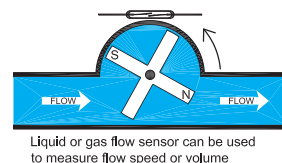

net is mounted on the propeller and a Reed Sensor is mounted outside of the plastic casing. In this case, each propeller rotation is counted as the magnet rotates past the Reed Sensor. The rotations are tallied and electronic circuitry converts the rotations to volumes of water (or other liquid) flowing through the pipes. In a similar manner, the flow of gas and electricity can also be measured. Our MK3 Sensor is often used for such applications, but we have many other sizes and shapes also worthy of your consideration.

Consumer Electronics



Sensors and switches make their way into many types of consumer electronics. Just about any application involving movement or the need to switch something on and off. A proximity sensor used in a cell phone or digital camera has a switch housed in the device and a permanent magnet positioned within the moving screen. Once the screen is rotated or slid to one side the magnet lines up with the switch contacts causing the screen to activate the phone or camera.

Another use for a reed sensor in a cell phone is when the phone is used with a docking station. When the phone is placed into the docking station, the magnet activates the switch causing the phone to go into hands-free mode or switches into car mode for the use of a global positioning system GPS.

Applications

- Barcode Scanner
- Camera screen activation
- Cell phone screen activation
- Chair lift

- Copier position sensors
- Electric toothbrush
- Hotel security card reader
- Hot Tubs & Spas
- Interlocking
- Keyboards
- Laptop closure sensing
- Massage chair
- Printer sensors
- Water flow sensor
- Utility meter sensors

Hobby & Toy

Today's toys are being designed with more and more moving parts requiring simple, reliable and inexpensive sensing solutions. Our magnetic reed sensors are a perfect fit in countless toy sensor applications.

For example: a baby doll that drinks a bottle may have a reed sensor positioned beneath the mouth and a permanent magnet molded into the bottle and when the bottle is held up to the it's mouth, the baby makes a drinking sound or stops crying.

Applications

- Car race track
- Baby doll position sensor
- Electronic board game position sensor
- Mechanical movement sensing
- Model train
- Video game peripherals



Safety and Security



Fire and Safety doors in public buildings, hospitals, government buildings, hotels and other buildings regularly frequented by people, require the doors to be shut at all times except in an emergency. By law, the doors must be electronically controlled; if they are opened, proper warnings must be given.

The topic of security gets more and more important – and Standex Electronics has the solutions for a lot of applications.

Safety Applications

- Passive infrared detectors
- Smoke and fire alarms
- Dial-up modems
- Ultrasonic detectors
- Cargo & freight theft prevention
- Door sensor
- Emergency door sensor
- Explosive Proof
- Fire extinguisher
- Hotel security
- Position sensor
- Vehicle restraint
- Window sensor

Door Sensor for Fire, Safety & Emergency Exit

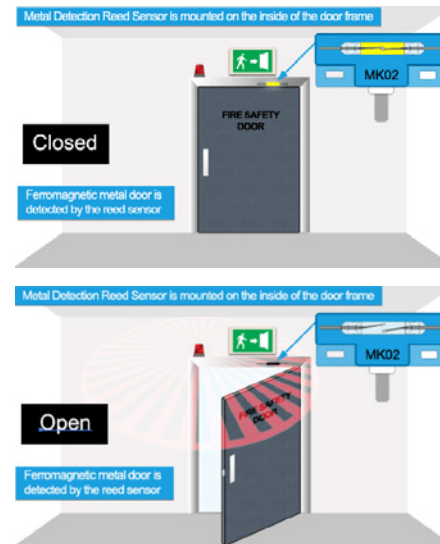

Hotel Security

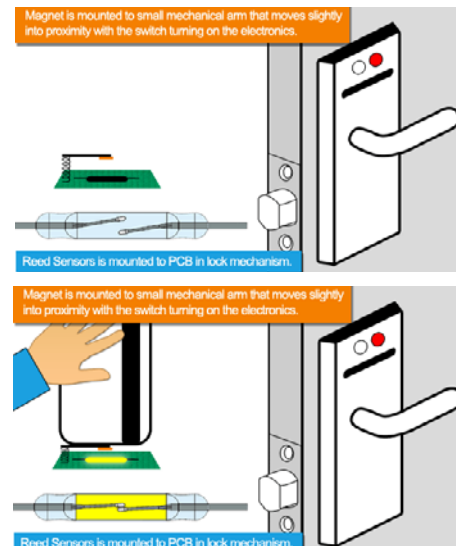

Medical



In portable and implantable devices it is equally important to utilize a switch that is ultra miniature and one that consumes the least amount of power. Reed switches and sensors consume no power in their normally open state. Reed Relays are used in many types of medical equipment that require high current and/or high voltage. Equipment such as an electrosurgical generator requires a high voltage relay to aid in regulating the right amount of current used to cauterize vessels during surgery. Similar equipment may use RF energy combined with saline to seal off vessels therefore high frequency relays would provide a maker solution.

Medical Applications

- Camera pill
- Handheld surgical tools
- Glucose monitor
- Hearing aid
- Implantable cardioverter defibrillator ICD
- Orthopedic micro power instruments
- Pacemaker
- Portable defibrillators
- Surgical Instruments
- Spine stimulator implant
- Video camera pill
- Hospital bed
- Lift chair position
- Mobility scooter
- Patient lift
- Power wheelchair
- Stair lift position
- Wheelchair ramp position
- Cleaning equipment
- Drug dispensing systems
- Electrosurgical generators
- EKG equipment
- Insulin pumps
- Intravenous pumps

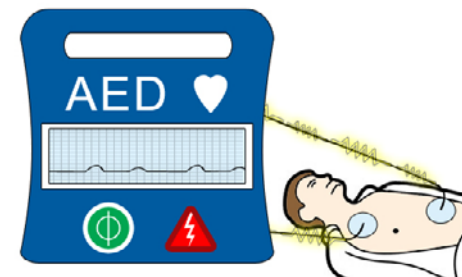

Portable medical equipment - Defibrillator

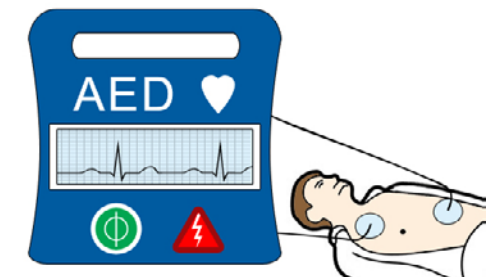

Test and Measurement

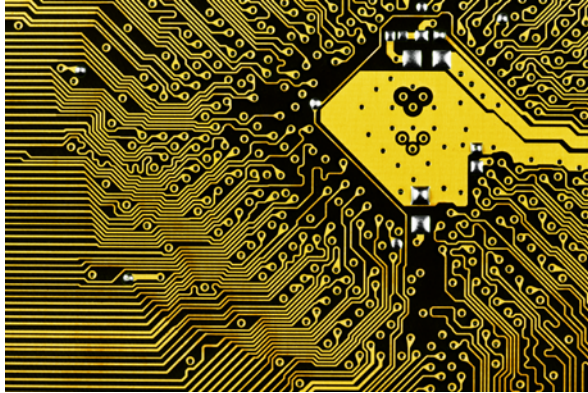

Test and Measurement Applications

- Automated Test Equipment
- Battery powered
- Cable testers
- Chip testers
- Data Acquisition/Scanning Systems
- Electrometer
- Functional PCB testers
- High voltage
- Industrial
- Integrated circuit testers
- Linear distance
- Medical equipment testers
- Modular Instrumentation
- Multimeters
- Network Analyzers
- Oscilloscopes
- RF Attenuators
- TVS Tester
- Wafer testers
- Weather meters

With the ever increasing requirements for electronics and electronic systems, the need exists to be able make voltage and current measurements covering several orders of magnitude. From nano-volts to kilovolts and from fempto-amps to amps. To do this with one instrument is almost impossible; however, multimeter designers have been able to expand the order of magnitude of these measurements in recent years. To be able to do this, the reed relay has become an essential component. Our specialized reed relays have helped designers meet this challenge.

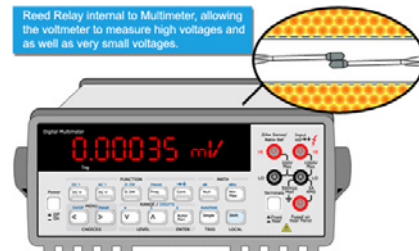
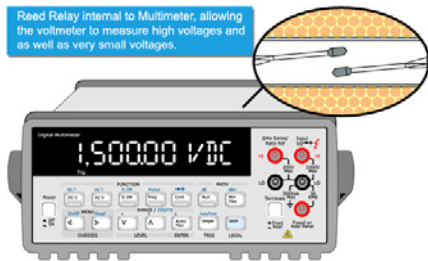

High End Multimeters Use Reed Relays to Measure Low & High Voltages

Telecommunication

The hermetically sealed Reed Switches can switch low signals, which are required for the various applications within the telecommunication sector.

Telecommunication Applications

- Device disabling
- Interlocking
- Mobile phone position sensing
- Off hook sensing
- Switching a cellular phone on/off in a flip phone
- Telephone line switching
- Cellular phone antenna switching
- Line sensing
- Line switching
- Modem switching
- Pager T/R switching
- Portable radios
- RF Receivers
- Test equipment

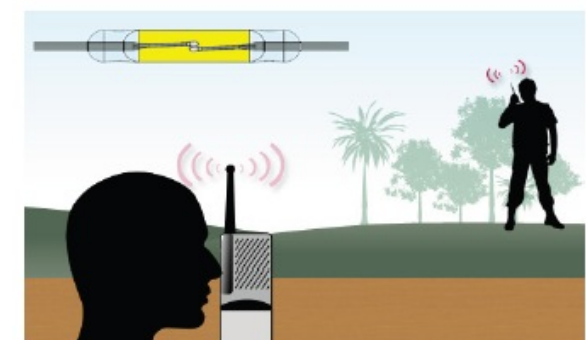
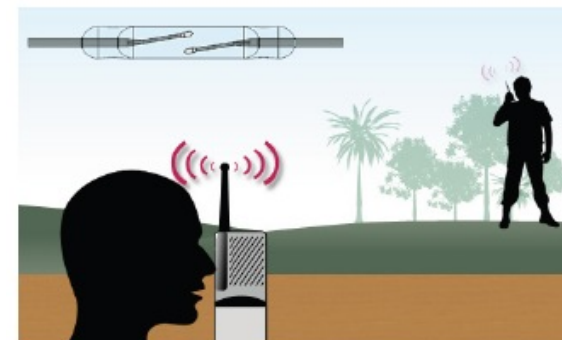

Reed relays for portable radios and communication systems

Further Applications

Many more Applications possible...

- Motor rotor sensing
- Thermostats
- Test and measurement equipment
- Rain gauge sensor
- Wind speed and direction sensing
- Barometric sensing
- Inside/outside temperature sensing
- Position sensor for exact window sun-shade control
- Solar panels
- E-Bikes brake detection
- Sensor solutions for agriculture, forestry and construction machinery
- Many more

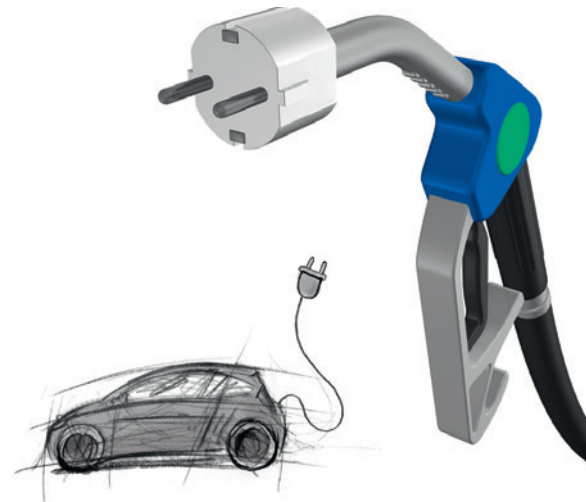

E-Cars connector detection

Visit our website at www.standexelectronics.com to explore our diverse range of animated applications, including and beyond what is offered in this book.



The Reed Switch used as a Reed Relay

In a Reed Relay, the Reed Switch uses an electromagnetic coil for activation and is shown in its simplest form in Figure # 1. Reed Relays require relatively little power to operate and are generally gated using transistors, TTL directly or cmos drivers. Reed Relay contacts, when switched dry, (currentless closure or less than 5 Volts @ 10 mA), will literally operate well into the billions of operations. In areas like automatic test equipment, where Reed Relays may be called upon to switch tens of millions of operations per year, the Reed Relay rises to the challenge.

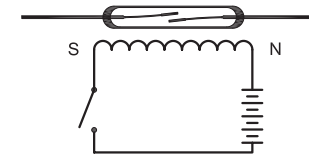

Fig. #1 A Reed Relay consists of a copper insulated wire wound coil with a Reed Switch traditionally mounted on its center axis.

Using the proper design, materials, placing an electrostatic shield around the Reed Switch internal to the coil and driving the shield, will allow coupling or passage of very small signals (nanoVolt signals or femptoAmpere currents) through the relay with little or no interference. See figure #2. This is virtually impossible with other technologies except at very high cost.

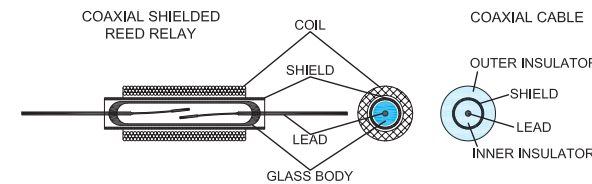

Fig. #2 Depiction of a Reed Relay showing the coil, Reed Switch, and shield (coaxial) placement.

Using a coaxial shield internal to the coil, the Reed Relay looks like a transmission line to high frequency signals. With Reed Switches becoming smaller and smaller, overall Reed Relay packages have shrunk to less than 8 mm long, reducing the distributed capacitance (switch to shield) to less than 0.8 pF. See figure # 3 This has allowed Reed Relays to carry frequencies up to 6 GigaHz without serious loss of signal strength (3 dB down). Typically, insertion losses as low as 0.2 dB and VSWR of 1.1 out to 2 GHz are now realizable. Reed Relays' RF characteristics rival the gallium arsenide mosfets and at 1 GHz and above are very cost competitive. Reed Relays are now commonly used in semiconductor test equipment and cellular telecommunication equipment because of their superior better RF characteristics.

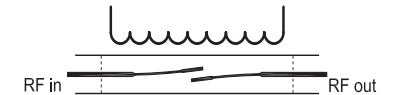

Fig. #3 A Reed Switch mounted internal to a coaxial shield provides an excellent RF path for Giga Hertz frequencies.

Numerous applications for Reed Relays exist today and are increasing every day. Please see our applications section for more detailed Reed Relay usage.

Reed Relay Applications

Introduction

Reed Relay applications continue to grow every year despite severe competition from other small switching devices such as semiconductors and electromechanical armature style relays.

Because the contacts in a Reed Relay are hermetically sealed, the contacts can switch low level signals as low as femtoamps and nanovolts. Electromechanical relays cannot do this because they are not hermetically sealed and have polymer films build up on their contacts that require a voltage arc to break through this layer before conduction can take place. Similarly, semiconductors have capacitance, leakage currents and semiconductor offsets to deal with that clearly limit the switching and detection of low voltages and currents.

Also, electromechanical relays, at best, can switch up to low millions of operations. Because its armature moves about a pivot point, wearing occurs, reducing life. The Reed Switch has no wearing parts and therefore, under signal conditions will switch into the billions of operation with fault free operation.

Reed Relays are ideally used for switching applications requiring low and stable contact resistance, low capacitance, high insulation resistance, long life and small size. For specialty requirements such as high RF switching, very high voltage switching, extremely low voltage or low current switching, again Reed Relays are also ideal.

Reed Relay Features

- Long life (10⁹ operations)
- Multi-pole configurations up to 8 poles
- Form A (normally open switching)
- Form B (normally closed switching)
- Form C (single pole double throw - normally closed contacts break before the normally open makes)
- Form D (single pole double throw - normally open contacts make before the normally closed breaks)
- Form E (latching – bi-stable state switching)
- Low contact resistance (less than 50 milliohms)
- High insulation resistance (greater than 10¹⁴ ohms)
- Ability to switch up to 10,000 volts
- High current carrying ability
- Ability to switch and carry signals as low as 10 nanovolts
- Ability to switch and carry signals in the femtoamp range
- Capable of switching and carrying signals up to 10 Gigahertz
- Operate times in the 100µs to 300 µs range
- Operating temperature from –55 to 100°C
- Capable of operating in all types of environments including air, water, vacuum, oil, fuels, and dust laden atmospheres
- Ability to withstand shocks up to 200 Gs
- Ability to withstand vibration environments of 50 Hz to 2,000 Hz at up to 30 Gs
- Very small sizes now available
- Auto-insertable
- Standard pin-outs
- Large assortment of package styles available
- Large assortment of Reed Switch options available
- Large assortment of coil resistances
- Relays can be driven in a current or voltage mode
- UL, CSA, EN60950, VDE, BABT 223ZV5 approved on many of our relays
- Magnetic shielding available on many of our relays

Reducing Magnetic Interaction in Reed Relay Applications

Reed Relays are susceptible to magnetic effects which may degrade performance under certain conditions. This report presents a practical approach to reducing magnetic effects among and between Reed Relays. The guidelines can be applied to many cases.

With the trend toward reducing the size of electronic equipment, Reed Relays are typically placed in proximity to one another. Magnetic coupling between relays can affect parameters such as pull-in and dropout voltage. In some circumstances, adjacent relays will be adversely affected by their neighbors.

Experimental data is provided for some basic Reed Relay arrays under worst-case conditions. An analysis of the data is presented with equations. The data was gathered on single in-line package (SIL) Reed Relays, but applies to most Reed Relay packages because the basic physical principles are the same.

A checklist for designing a relay array or matrix covers the factors necessary to minimize the electromagnetic effects most likely to be encountered. Systematically progressing through the checklist will aid in reducing or eliminating many troublesome variables

Factors Affecting Reed Relay Magnetic Interaction

A host of factors, internal and external, determine how a Reed Relay will perform when installed in a matrix assembly and subjected to electromagnetic interference (EMI).

Internal Factors: Early in the design phase, the user and the manufacturer must discuss the application and consider all the internal factors:

- Coil wire gauge
- Coil resistance
- Coil ampere-turns (AT)
- Coil winding direction
- Coil winding terminations

- Type of Reed Switch assembly
- Number of Reed Switches in the relay
- Internal magnetic shielding

External Factors: Controlling external factors generally is accomplished by giving proper attention to the operating environment of the Reed Relay. How much effort is expended on these factors will depend on how strongly they adversely affect design performance. Consideration should be given to these factors:

- Nearby magnetic fields
- Relay spacing in the relay matrix
- Magnetic polarity arrangement
- External magnetic shielding

Magnetic Coupling between Reed Relays

To better understand the magnetic coupling between adjacent Reed Relays, consider this example. Figure #4 shows a portion of a relay matrix with two adjacent Reed Relays mounted on a PC board. The relays, K1 and K2, are identical in construction and the direction of current flow is the same in each.

Magnetic field lines are shown when both relays are energized. When K1 and K2 are energized, their opposing magnetic fields will adversely affect each other. This is shown where the field of K2 is extended into the body of K1.

When K2 is energized and K1 is not operating, the pull-in and dropout voltage of K2 is within the range of the manufacturer's specifications. Attempting to energize K2 when K1 is operating results in an increase of the pull-in and dropout voltage for K2, perhaps beyond the manufacturer's limits.

When K1 is energized with a current flowing opposite to that in K2, an attempt to energize K2 results in lower pull-in and dropout voltages.

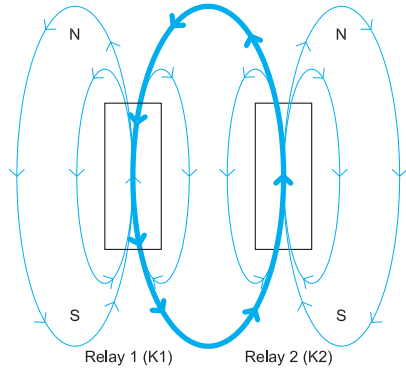

Fig. #4 Magnetic Interaction Effects in Reed Relays

Experimental Data on Topical Relay Matrices

Relay matrices can be configured in a number of ways. In this analysis, data is presented on five typical configurations.

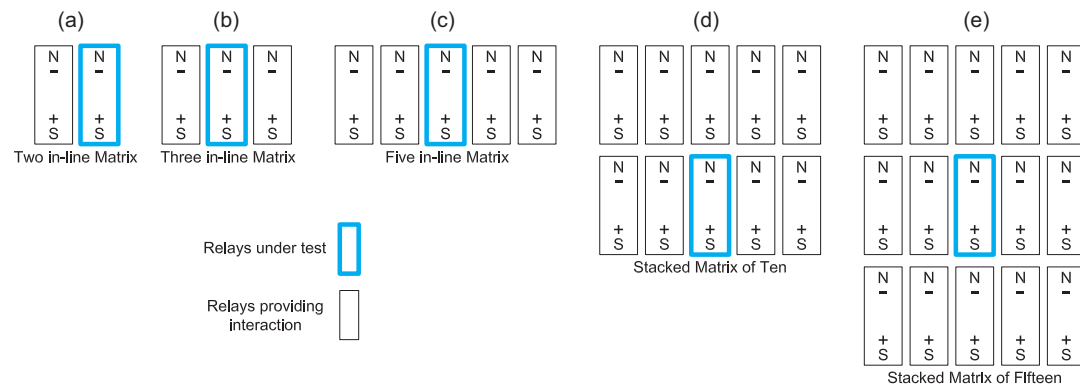

Fig. #5 Relay Test Configurations: (a) Two In-Line Matrix; (b) Three In-Line Matrix; (c) Five In-Line Matrix; (d) Stacked Matrix of 10 and (e) Stacked Matrix of 15.

rations. Polarity considerations also have been limited. The configurations and magnetic polarities presented demonstrate some worst-case effects of relay-magnetic interaction.

Experimental Setup

Experimental data was gathered on 0.20" wide molded SIP relays. The test matrix configurations are shown in figure #5.

Data was taken while all relays surrounding the relay-under-test (RUT) were energized with the same magnetic polarity. Once all relays were energized, the RUT (with the same magnetic polarity as its neighbors) was incrementally energized to the pull-in point. The dropout voltage data was taken in a similar manner.

All data was gathered using a 5V coil drive. With higher voltage coils that generate equivalent ampere turns, the results are similar. Higher ampere-turn coils produce slightly higher interaction effects. For data presented on magnetically shielded relays, the magnetic shielding is internal and an integral part of the relay (fig. #6).

Data Analysis

In general, near worst-case magnetic interaction conditions for pull-in voltage in a matrix exist when all relay fields have the same polarity and all the fields are from adjacent relays (fig. #5). The interaction is somewhat reduced when the matrices have relays mounted end-to-end (figure 5d and 5e). This effect can be seen in figure 6b.

Under the expected worst-case conditions presented, dropout voltage is not really a concern since it increases and tracks the pull-in voltage, maintaining approximately the same voltage change. The dropout voltage may become a major concern if the magnetic polarity of adjacent relays is opposite to that of the RUT (aiding). This situation can be avoided by assigning appropriate voltage polarities to the relays and using relays of consistent manufacture.

The change in pull-in voltage (ΔPI) is defined as the pull-in voltage with interaction effects minus the pull-in voltage without interaction effects. Percent increases for the pull-in voltages presented were calculated at the 5-V nominal coil voltage. Stated mathematically,

$$\% \Delta PI = \Delta PI(100)/5 \text{ volts}$$

Equation #1

For a given matrix, the change in pull-in voltage essentially remains the same for all relays having pull-in voltages of various levels. If one relay without interaction, for example, has a pull-in voltage of 2.3 V, it will shift to 2.7 V with interaction (ΔPI of 0.4 V). Now consider a second relay in the same matrix under the same conditions that has an initial pull-in of 2.6 V. With interaction, the pull-in voltage will rise to 3.0 V (again the ΔPI is 0.4 V).

Calculating the Effects of Magnetic Interaction

To further examine the magnetic interaction effects on Reed Relays, consider an example using the three-relay matrix of 5-V SIL relays in figure #5b on 0.20" centers (no magnetic shielding). All testing will be performed on the center relay which has an actual pull-in voltage of 2.6 V by itself. The outer two relays are activated with 5 V applied to the coil.

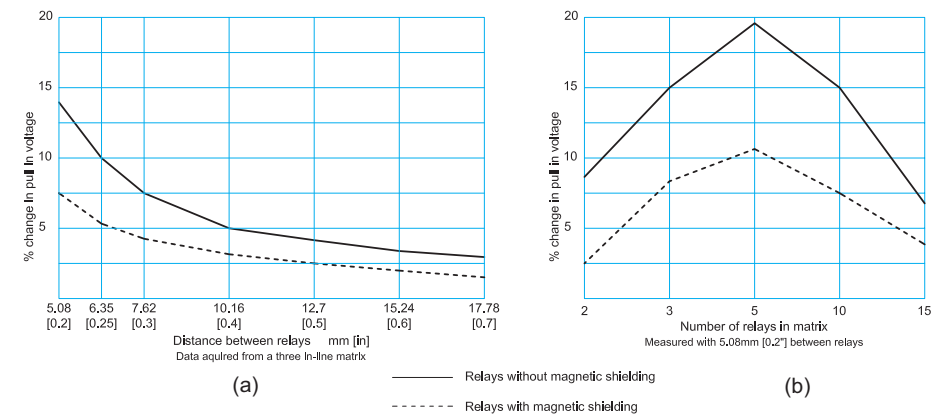

Fig. #6 (a) Percent Pull-In Voltage Increase vs. On-Center Distance Between SIL Relays. Data was taken using the three-relay test matrix (see Figure 5). (b) Percent Pull-In Voltage Increase vs. the Number of Relays in the test configuration, using matrix for up to 15 relays.

The center relay will be energized and the expected pull-in voltage change can be calculated.

First calculate the pull-in voltage change. For the example, these equations will be used:

$$\Delta PI = (\% \Delta PI \times V_{nom}) / 100$$

Equation #2

Where ΔPI = the expected pull-in voltage change.

$\% \Delta PI$ = the percent interaction calculated at the nominal voltage and shown in the graphs of experimental data. V_{nom} = the nominal coil voltage as specified by the manufacturer.

$$PI_{wc} = PI_{act} + \Delta PI$$

Equation #3

PI_{wc} = the worst-case increased pull-in voltage under interactive conditions.

PI_{act} = the actual pull-in voltage without external magnetic interference.

Referring to figure #6a, at a nominal coil voltage of 5 V, the magnetic interaction is 14.2%. Using equation #2 to calculate ΔPI :

$$\Delta PI = (14.2 \times 5) / 100 = 0.71 \text{ volts}$$

The relay has an actual pull-in voltage of 2.6 V. Therefore, the near worst-case pull-in voltage can be calculated using Equation #3:

$$PI_{wc} = 2.6 + 0.71 = 3.31 \text{ volts}$$

Equation #4

The value calculated for PI_{wc} is perhaps the worst case for the given matrix under all possible polarity (magnetic and electrical) conditions. The value calculated for ΔPI is a close approximation over the entire pull-in voltage range.

Furthermore, $\Delta PI \sim \Delta DO$; that is, the dropout voltage change in the matrix closely follows the change in pull-in voltage. For example, in the calculation for PI_{wc} , if the dropout voltage was measured to be 1.4 V without magnetic influence, its value will change to 2.11 V for the conditions described. Except for rare cases where special dropout conditions are required, dropout voltage changes as described do not present a problem.

Ways to reduce Magnetic Effects

- Specify Reed Relays with internal shielding
- Use external magnetic shielding on the matrix
- Provide for larger spacing between relays
- Avoid simultaneous operation of adjacent relays
- Design a special matrix configuration

Special Conditions

For conditions presented in figure #6, the data was taken on single unenergized relays surrounded by energized relays. In many actual applications, the relays are energized under a host of different circumstances. Typically, banks of relays are energized together.

For example, the data gathered in Figure 5a will be reduced by approximately a factor of two by energizing the relays in the same matrix in this manner: energize all relays simultaneously with a ramping voltage while monitoring the center relay.

Here the interaction effects will be reduced by a factor of two. This same effect will be observed with faster and faster ramp speeds (approximately a step function) if the relays are still energized simultaneously.

This reduction in interaction occurs because of the reduced surrounding magnetic fields present at the time of contact closure, where the actual pull-in voltages are typically half the nominal voltage.

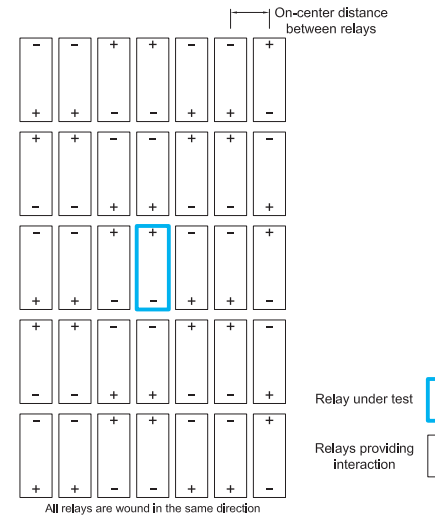

Fig. #7 Alternative Pairs Relay Test Configurations.

Special Matrix Applications

Under certain conditions, the consistent direction in which the coils are wound and terminated, particularly when mounted close together, can reduce the magnetic influence.

The matrix shown in figure #7 uses the opposing magnetic polarities and consistent coil manufacture to reduce interaction without the added cost of magnetic shielding. This effect (fig. #8) is achieved by wiring the matrix as shown in figure #7.

The data presented in figure #5 can be compared to the data presented in figure #6 for a similar nonmagnetically shielded SIL matrix of 15 where the polarities are in the same direction. The improvement or reduced interaction is 2.5 % in figure # 8 compared to 6% in figure #6.

Checklist for Designing a Relay Matrix

1. Applied Voltage
2. Temperature Effects
3. Available PC board space
4. Distance between adjacent relays
5. Energizing the matrix
6. Magnetic shielding
7. Life Characteristics
8. Design Analysis

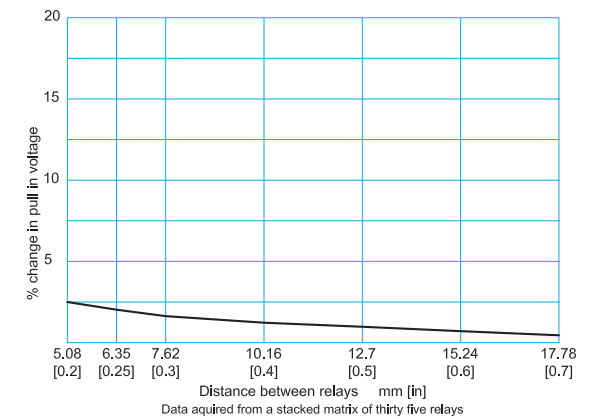

Fig. #8 Alternate Pairs Matrix.

Reed Relays in Comparison with Solid State and Mechanical Relays

1. **Applied Voltage:** The power supply under maximum load and at 50 °C can be as low as 4.9 V minimum. Under some circumstances, the load voltage may be in series with transistor/diode drops of 0.7 V maximum over the operating temperature range. The working voltage of the power supply is reduced to 4.3 V, the actual voltage applied to the relay coil.
2. **Temperature Effects:** If the maximum system operating temperature is 50 °C and the specified relay pull-in voltage is 3.6 V maximum at 25 °C for a 5-V nominal coil voltage, a rise in voltage from 3.6 V to 3.96 V maximum at 50 °C can be expected.
3. **Available PC Board Space:** A 5 x 10 relay matrix (50 relays) is required. To fit the relays on the board, a crowded arrangement must be employed (only 7.75 in.2 of board space is available).
4. **Distance between Adjacent Relays:** The relays must be placed on 0.20" centers, five rows of 10 relays each.
5. **Energizing the Matrix:** In this application, a maximum of three relays is energized simultaneously. Figure #6a presents the interaction data required for this application. Here the worst case occurs for the non-magnetically shielded 0.20" separation and is 7.5 %. By using equation 2, the interaction effects are calculated as a worst-case pull-in voltage increase of 0.38 V.
6. **Magnetic Shielding:** It is decided not to use magnetic shielding.
7. **Life Characteristics.** In general, when switching intermediate to high-level loads, the coil voltage overdrive should be about or equal to 100% (about or equal to two times the actual pull-in voltage) for best-life characteristics. Here the relay coil overdrive is small; however, only low-level switching is

expected. Therefore, the life characteristics should not be affected.

8. **Design Analysis:** If the results found in item 5 were added to the results in item 2, the maximum pull-in voltage will rise to 4.34 V under interactive conditions. This exceeds the minimum voltage of 4.3 V. Probably the two simplest approaches at this point are increasing the power supply voltage or lowering the initial maximum pull-in voltage rating from 3.6 V to at least 3.2 V maximum. This would leave sufficient added overdrive under worst-case conditions.

Summary

Magnetic interaction effects on Reed Relays can represent a significant problem if ignored. Many solutions are possible.

The foundation for determining worst-case scenarios on the basic matrix types is presented in this article. A systematic approach to designing a relay matrix can be achieved by referring to the checklist provided.

It is strongly suggested that the user consult with the relay manufacturer early in the design process. Following this methodology will greatly diminish the potential for unpredictable relay matrix performance.

Specifications	Reed Relay	Mechanical Relay	Solid State Relay
Switching Time	100 μs - 1 ms	> 5 ms	< 100 μs
Life Expectance: Low Level	10 ¹⁰ cycles	10 ⁶ cycles	Nearly unlimited
Power Consumption	3mW possible	50 mW	3mV possible
Switching Voltage	10 kVDC	1.5 kVDC	1.5 kVDC
Switching Current / Carry Current	Max. 3A/Max. 5A	Up to 40A	Up to 40A
Load Minimum	No load requirement (μV/pA)	50mW	50mW
Insulation Resistance	10 ¹⁴ Ohm	10 ⁹ Ohm	10 ⁹ Ohm
Noise	No switching noise	Partly high switching noises	No switching noise
Insertion Loss	Low (0.5dB)	Low (0.5dB)	High (2dB)
Overload	Very sensitive	Insensitive	
General	Linear graph from DC to GHz range	Linear graph from DC to GHz range	Distortion of the signal
General	Galvanic isolation (air gap)	Galvanic isolation (air gap)	No galvanic isolation (low/high)

7 GHz RF-Reed Relays – Applications

CRR- and CRF-Reed Relays for usage in Automated Test Equipment

CRR for functional test systems. Functional test systems continue to grow in size, pin count and complexity. Each pin usually requires 3 to 5 test connections. Each test connection needs to be isolated from all the others. Introducing any leakage paths thwarts the signals under test potentially shunting them to the point where they lose their functionality.

Because of the high pin counts, the number of test connections grows dramatically. Here the need to satisfy these test connections with an ultra small surface mounted relay (CRR series) becomes ideal with the following specifications:

1. Extremely small size (8.6 x 4.4 x 3.55 mm)
2. Ability to mount the Reed Relays on both sides of the board
3. Standard internal magnetic shielding eliminating any magnetic interaction even in the tightest matrices
4. Insulation resistance to all points typically 1014 ohms
5. Over 200 volts isolation across the contacts
6. A minimum of 1500 volts isolation between switch and coil
7. Thermal offset voltage across the contacts in the one microvolt or less range
8. Contact capacitance is less than 0.2 pf

CRF-Relays for wafer, memory, and integrated circuit test systems. Integrated circuit and wafer testers have continued to take on an ever more complex format with the need for faster and faster clock rates. With clock rates in the 2 GHz range, components must be able to pass continuous wave signals with frequency responses in the 8 to 10 GHz range. These fast switching high speed digital signals require these new frequency responses so that signals are not slewed or reflected going through the switching components in these systems..

The CRF Reed Relay represents an ideal switch in these component testers for the following reasons:

1. The frequency response of 7 GHz is a current critical need
2. Rise time change through the relay of 40 picoseconds typical
3. High return loss
4. Insertion loss less than 1 dB at 6 GHz
5. Extremely small size
6. Ability to mount the Reed Relays on both sides of the board (with internal magnetic shielding eliminating any magnetic interaction)
7. Insulation resistance to all points typically 1014 ohms
8. Over 200 volts isolation across the contacts
9. A minimum of 1500 volts between switch and coil
10. Thermal offset voltage across the contacts in the one microvolt or less range
11. Contact capacitance less than 0.2 pf
12. Open contacts to shield capacitance 0.6 pf

Instrumentation (CRR and CRF)

1. On measuring input of multimeters where voltage isolation is required, low voltage offsets (on the order of 1 microvolt or less) and very low sub-picoamp leakages are needed.
2. Feedback loops where high frequency, low leakage, and voltage isolation are required
3. In Attenuators where a high frequency response is required, low leakage paths are essential, long life (in excess of 100 million operations), and elimination of any inter-modular distortion is a clear need.

Multi-pole Configurations

When circuits require common points tied together, capacitance becomes a real problem. Trying to reduce this capacitance can be a real effort with no clear solution. Using our new relay approach multipole relays with common tie points are no problem configuring with resulting reduced capacitance. Relay drivers, connectors, etc. can be easily added forming RF switching modules, RF attenuators, T/R switches, 'T' switches, etc.

DIMENSIONS

*All dimensions in mm (inches)

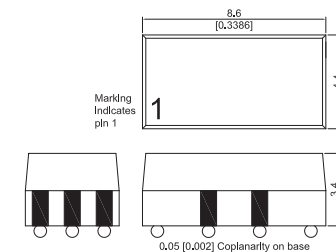

PIN OUT (Top View)

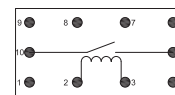

PAD LAYOUT

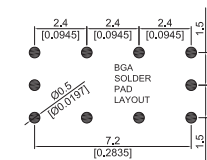

POST REFLOW

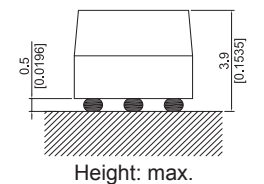

Fig. #9 Mechanical layouts with Ball Grid Array (BGA).

Applications Notes for RF-Relay Measurement in both the Frequency and Time Domain

Most important in the testing of any component for frequency response over 100 MHz is a good Network Analyzer and carefully designed test fixtures for calibration as well as for the actual testing. The same is true when testing in the time domain. When measuring rise time characteristics, one must be aware of overshoot and undershoot of the rise time pulse that may affect the signal quality adversely.

Fixture design starts with suitable SMA connectors on high frequency board material. There are several materials suitable for this including FR-4, G-Tech materials, and several Rogers PCB materials. Many feel FR-4 material is suitable since the fixture zeroing process will eliminate its high frequency loss characteristics. As a general rule, below 6 GHz is okay; above 6 GHz use of Rogers high frequency circuit materials such as, RO3203 or RO4350 will improve the test performance. Rogers has several other materials available depending upon the TCE matching of the component/s or performance requirements. Most of these materials are ceramic filled.

Figures 15, 16, 17 and 18 below show calibration board layouts for a shorted to ground, and open circuit, through line transmission, a 50 ohm impedance termination, and the layout used to test the device. As many ground points as possible were used along with avoiding and sharp corners. All signal path transitions were made as gradual as possible.

Once the calibration testing was completed, our test process was as follows using an Agilent Network Analyzer Model number 8720ES (See test layout in figure #14).

All calibration boards were entered into the network analyzer and stored. The relay under test was then measured and stored. The calibration data was then entered and the losses due to the board under the various configurations was extracted yielding the results shown below. This was compared with data extracted from a MIMICAD program using the equivalent circuit presented and the S parameters; and it was found both tracked very closely.

See the results from the data shown below taken from network analyzer. Included are the isolation, insertion loss, and VSWR. Also, included below is a Smith chart indicating the impedance for a given frequency over the entire frequency range.

Fixture Design

Definition of the exact geometry your test fixture will take is the first key step. Listed below are four geometries and their corresponding equations for calculating the characteristic impedance.

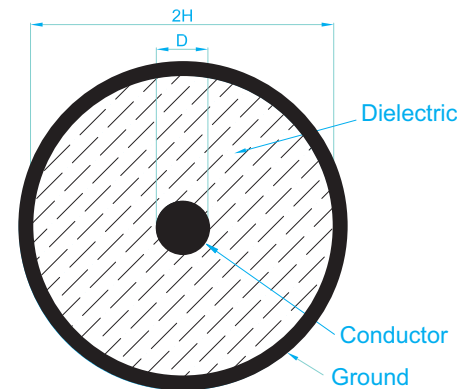

Fig. #10 Coaxial cable geometry

$$Z_o = 60/(\sqrt{\epsilon_r}) \ln ((2h)/d)$$

Equation #5 (for a coaxial cable)

Where h and d are defined above and ϵ_r is the dielectric constant for the material between conductors.

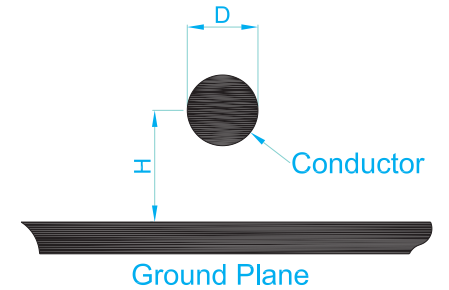

Fig. #11 Round wire over a ground geometry.

$$Z_o = 60/(\sqrt{\epsilon_r}) \ln ((4hk_p)/d)$$

Equation #6 (for a round wire over ground)

for a round wire over ground

Here k_p is the proximity factor for round wire over ground, which is near unity when the ratio h/d is large; but for close spacing is approximately

$$k_p = \frac{1}{2} + (\sqrt{(4h^2 - d^2)})/4h$$

Equation #7

k_p is reduced to $\frac{1}{2}$ when the round wire touches the ground at $d = 2h$. The proximity effect results from the same mechanism as skin effect. Mutual repulsion drives like currents to the extreme outer edges of individual conductors carrying current in the opposite direction. This crowds the current in round wires toward the side nearest a ground. As is the case while signal is going through the relay, the proximity effect and skin effect are indistinguishable for a coaxial line because the entire surface of the round center conductor is at the same distance from the shield. Proximity effect is not normally considered for thin rectangular conductors, but skin effect does drive the currents toward the edges of the conductors.

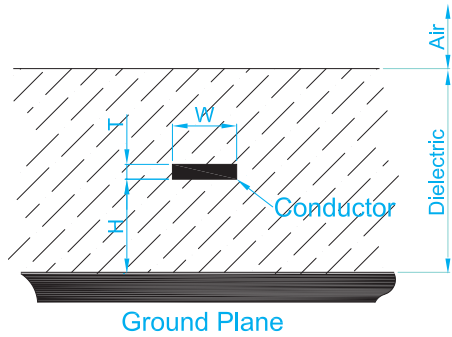

Fig. #12 Buried microstrip geometry.

$$Z_o = 60 / (\sqrt{\epsilon_r}) \ln ((5.98h) / (0.8w + t))$$

Equation #8 (buried microstrip over ground)

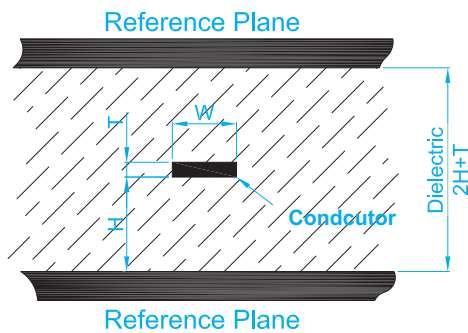

Fig. #13 Stripline geometry.

$$Z_o = 60 / (\sqrt{\epsilon_r}) \ln (3.8(h + 0.5t) / (0.8w + t))$$

Equation #9 (Stripline between ground planes)

Test Setup and Test Fixtures

Key to the proper testing of a component in an RF circuit is the proper use of test fixtures.

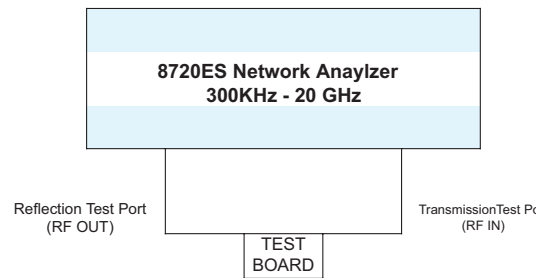

Fig. #14 Test Setup.

Calibration Approach Critical

- The fixtures were constructed to serve as calibration boards to allow for better characterization of the relays. All the fixture boards used to test the relays under test (RUT) used SMA connectors for connection to and from the test equipment and for terminations. The following are the makeup of the boards under test:
- RUT calibrated with a 50 ohm line and open termination
- RUT calibrated with a 50 ohm line and shorted termination
- RUT calibrated with a 50 ohm line and 50 ohm termination
- RUT calibrated with a 50 ohm through line

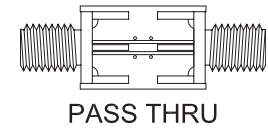

Fig. #17 Through line transmission termination board.

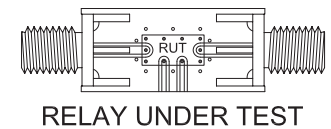

Fig. #18 Relay under test termination board.

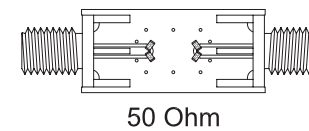

Fig. #15 50 Ohm termination board.

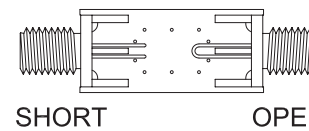

Fig. #16 Open/short termination board.

Insertion Loss

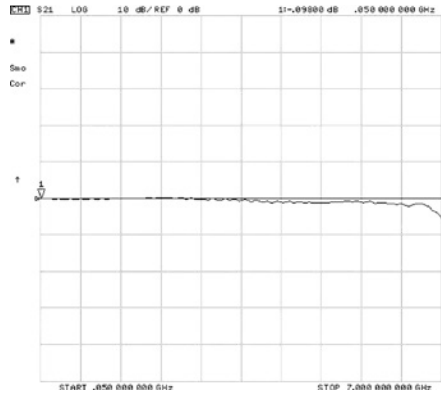

Fig. #19 Insertion loss tested to 7 GHz for the Reed Relay shown in figure #9.
Horizontal full scale: 7.0 GHz.
Vertical scale: 10 dB/div referenced from the 0 mark.

Copper Wire Insertion Loss

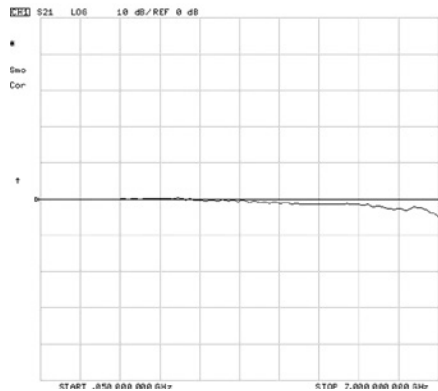

Fig. #20 Insertion loss tested to 7 GHz for the Reed Relay shown in Figure # 9 but with the internal Reed Switch replaced with a bare copper wire.
Horizontal full scale: 7.0 GHz.
Vertical scale: 10 dB/div referenced from the 0 mark.

VSWR

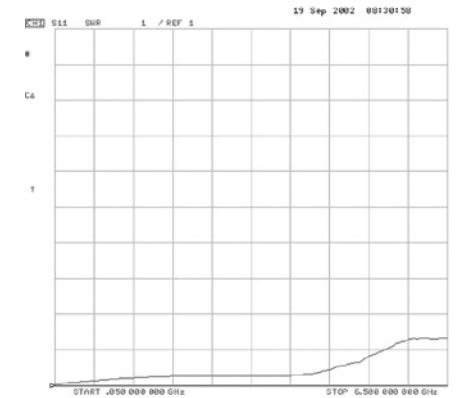

Fig. #21 Voltage Standing Wave Ratio (VSWR) tested to 6.5 GHz for the Reed Relay shown in figure #9.
Horizontal full scale: 6.5 GHz.
Vertical scale: 1.0/div referenced from the bottom line 1.0 mark.

Isolation

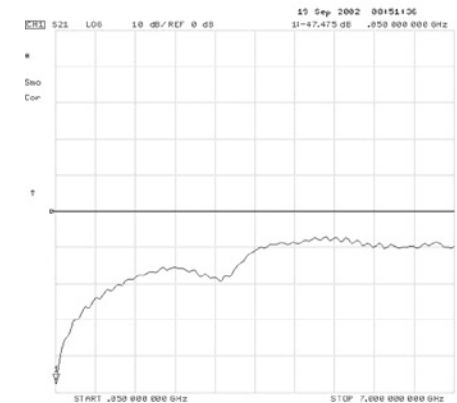

Fig. #22 Isolation tested to 7 GHz for the Reed Relay shown in figure #9.
Horizontal full scale: 7.0 GHz.
Vertical scale: 10 dB/div referenced from the 0 mark.

Return Loss

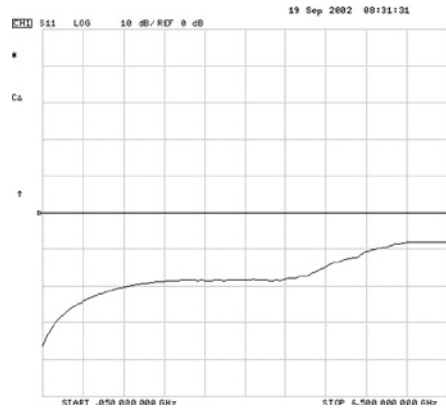

Fig. #23 Return loss tested to 6.5 GHz for the Reed Relay shown in figure #9. Horizontal full scale: 6.5 GHz. Vertical scale: 10 dB/div referenced from the 0 mark.

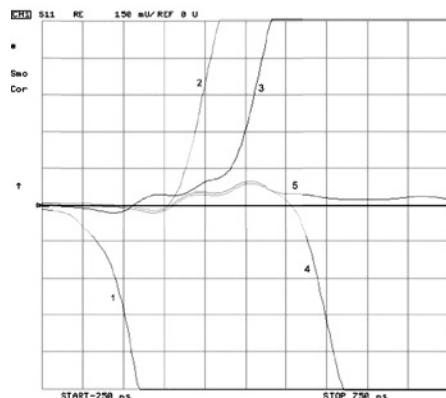

Fig. #24 Represents the characteristic impedance going through the Reed Relay shown in figure #9. Waves 1 through 5 depict calibration points. Horizontal full scale: 750 ps. Vertical scale: 150 milliUnit/div referenced from the 0 unit mark. The vertical scale measures the reflection coefficient.

- 1 - Short Before Relay
- 2 - Open Contacts
- 3 - Close Contacts
- 4 - Closed Contacts - Shorted
- 5 - Closed Contacts - 50 Ohm

Smith Chart

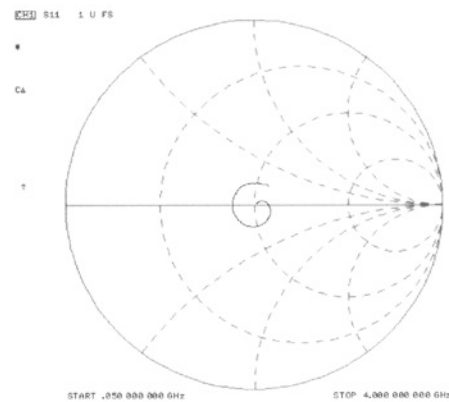

Fig. #25 Shows a Smith Chart plotted for frequencies to 4 GHz. The second dotted circle starting from the right is the 50 Ohm impedance point.

Test Results

Figures #19 through 25 represent the results of our testing using the procedures previously described and the fixtures presented. The fixtures used were made from FR-4 printed circuit board material. Improvements to the fixturing, using some of the Rogers PCB material may improve the results.

Insertion Loss

As explained earlier, insertion loss is the loss of power going through the relay. Insertion loss is one of the most important measurements in RF because it is simply a measure of the loss of the signal going through the component (Reed Relay). Minimizing this loss is a key interest.

First, it can be clearly seen that the insertion loss looks excellent up to 7 GHz, as shown in Figure # 19. As shown, the insertion loss curve is very flat and begins to tail off at 7 GHz. Clearly, this indicates signals, whether digital or analog, will fare very well when switched and passing through this CRF ceramic Reed Relay. When using semiconductors as a switching element, intermodulation distortion may sometimes occur, giving rise to distortions in the frequency response. With a passive device such as the Reed Relay, no intermodulation distortion exists, resulting in a very flat insertion loss up to 7 GHz. Having this very flat insertion loss allows the user the ability to switch, carry or deal with a multitude of different frequencies or different width digital pulses, without having to worry about having different switches to handle the different frequencies.

At higher and higher frequencies, it has been proposed that a Reed Relay, because it uses nickel/iron as its center conductor, will not have very good performance characteristics. Skin effect is often the proposed culprit, because nickel and iron, being ferromagnetic, have a high magnetic permeability μ . However, this is not the case as shown in figure #20, where the Reed Switch in figure #9

was replaced with a pure copper wire. Comparing figures #19 and #20, one sees little or no difference. Under high power transmission conditions, a difference would probably be seen. But as is the case in many applications, the power being switched is very low; and therefore, we only see a negligible effect up to seven GHz.

VSWR

VSWR represents the effects of the transmission of power due to standing waves. When standing waves are present on a line, some power is being reflected back on the line and re-reflecting again from the source. This back and forth reflection produces standing waves. These standing waves interfere with the transmission of the original signals from the source because they are continuously present and continually absorb power. Figure #21 presents the VSWR for the Reed Relay shown in Figure # 9. While still an important RF characteristic for analog continuous wave analysis, insertion loss is looked on more for RF characteristics.

Isolation

Isolation is the ability of a component to isolate the RF signal from propagating further in a circuit. For a Reed Relay, the isolation is a measure of the ability to halt further progress of the signal when it is in the open state. We all think of a switch in the open state as meaning no signal passes beyond those open contacts. However, with RF we know an open circuit is not totally open because the capacitance across the contacts represents a leakage path; and indeed with high enough frequencies, that's exactly what occurs. Presented in Figure #22 one can see isolation of -50 dB or greater at low RF frequencies which drops to -15 dB at 3 GHz and continues to a level of -10 dB at 7 GHz. Contributing to this drop off in isolation is the contact gap. Increasing the gap on the Reed Switch is very difficult to do because it would require a larger capsule, which would increase the package size. Also, a larger gap will make the switch less sensitive for closure, requiring more coil power. If the isolation is a

critical parameter in an application, stringing more than one Reed Relay together will help. Also using a 'T' switch or half 'T' switch will yield much higher isolations.

Return Loss

Return loss is also an RF parameter that is not used as much as the insertion loss or isolation. As stated, it is a measure of the power of the RF signal being reflected back to the source. As can be seen in Figure #23, the return loss has only 35 db of reflected signal at the lower frequencies and about 10 db reflected back at 6.5 GHz. Here the larger the dB level the lower the percentage of the signal being reflected.

Characteristic Impedance

To gain most information from a characteristic impedance measurement of the relay it is fruitful to make measurements of the signal up to certain points while going through the relay. Since this measurement is a spatial measurement, the actual impedance at each point of the relay can be measured. The following points of reference were made as shown in Figure #24:

1. A short before the relay defining when the signal enters the relay
2. Open contacts define the signal up to the middle of the relay
3. Closed contacts define the signal path up to the end of the relay
4. Closed contacts with the relay shorted
5. Closed contacts with the relay terminate in 50 ohms

Superimposing the 5 traces on the actual trace through the relay, a full picture of the characteristic impedance can be seen at each point through the relay. This is very valuable particularly if the relay or component is slightly off the 50 ohm impedance. As shown in the trace in Figure #24, the relay is slightly above 50 ohms. With the trace being high, this indicates a slightly inductive entrance into and out of the relay. Compensating with a

little capacitance on each end of the relay will tune the impedance to the desired level. This will in turn improve the performance of the relay in a given circuit and increase its performance at higher RF frequencies as well.

Smith Chart

If one is looking at different RF frequencies in a given application or at a specific frequency, a Smith Chart can help by presenting the characteristic impedance over a given frequency range. The Smith Chart presents a plot of the response of frequencies every 50 KHz up to 4 GHz. Shown in Figure # 25, the plot of points is centered around the 50 ohm real point. To better understand this Smith Chart, the second dotted circle starting from the right center point of the large circle is the 50 ohm impedance circle. The center line of the circle running horizontally, is the real axis. Plots above this line are inductive and plots below this line are capacitive. As shown, the plot of the CRF relay is in a tight circle around the real axis, and centered around the 50 ohm circular axis.

Summary

As can be seen the CRF Reed Relay is an excellent Reed Relay for switching and carrying RF signals at least up to 7 GHz and beyond. Our current efforts are to improve its characteristics up to 10 GHz and beyond. This is a reachable goal as we try to continually develop new RF relays, pushing the current bandwidth and current 'state of the art'. As higher and higher frequencies are used and components are needed to develop these circuits, the need for Reed Relays like the CRF series and subsequent improvements on performance over existing data will be needed. Our engineers are up for this challenge.

Life Requirements

The life of a Reed Switch can vary widely depending on the exact switching circumstances. Over the years, many improvements have been made to the Reed Switch, which have played a major role in improving its reliability.

Reed Switches, because of their hermetically sealed properties and no wearing parts, will switch no load or signal loads into the billions of operations, in most cases with minimal contact resistance changes. In fact, over long life at no load, the contact resistance will often times drop approximately 5 mOhms to 10 milliohm.

Standex Electronics offer several different types of switches ranging from 4 mm long to 50 mm long, capable of switching nanoVolts up to 10,000 Volts; capable of switching femtoAmps up to 5 Amps, and capable of switching DC on up to 6 GigaHz. Generally speaking, we offer Reed Switches in Sensor or Relay applications having tungsten, rhodium, ruthenium, palladium or iridium contacts.

When trying to optimize your life requirement be sure to consult our precautions selection. Several areas of concern are discussed both mechanically and electronically. The load section in particular will give you important insight when switching any loads with inductance, capacitive, or inrush current loads.

It is always best to test the particular switch under actual switching loads for the life you require. A life test offers a high level of safety.

Activate Distance

Resulting from position and movement of the actuator magnet.

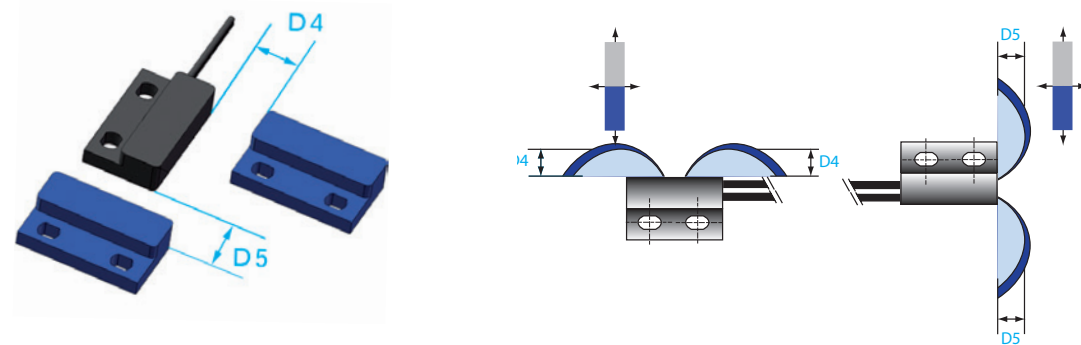
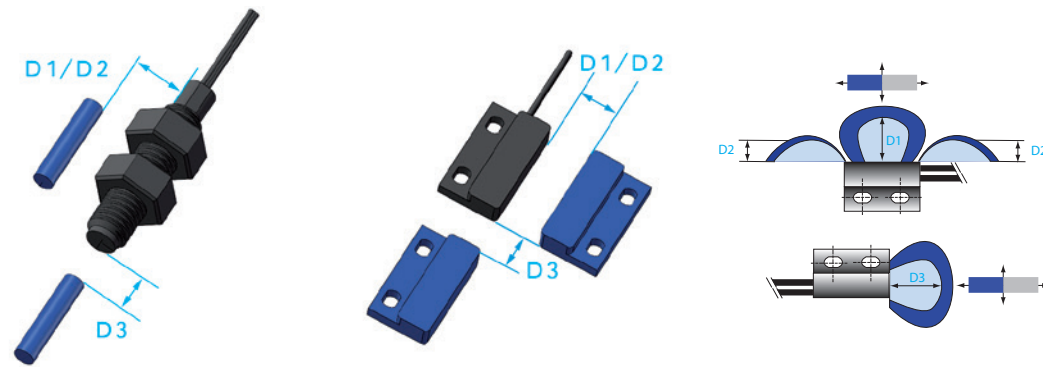

Note: The mentioned distances in millimeters in the table are typical values, they can differ in applications.

Type	Part-No.	Magnetic Sensitivity	Position and Movement max. Pull-in Distance in mm					Position and Movement min. Drop-out Distance in mm				
		mT	D1	D2	D3	D4	D5	D1	D2	D3	D4	D5
MK03-1A66B-500W	2232711054	> 1,70	15,0	6,5	9,3	8,5	8,5	17,5	8,0	11,4	10,1	10,1
MK03-1A66C-500W	2233711054	> 2,30	13,0	4,4	7,4	7,2	7,2	16,5	6,5	9,9	9,5	9,5
MK03-1A66D-500W	2234711054	> 2,70	11,0	4,0	5,7	6,5	6,5	14,5	5,5	8,5	9,0	9,0
MK03-1A66E-500W	2235711054	> 3,10	10,0	3,5	4,5	5,7	5,7	13,5	5,0	8,0	8,5	8,5
MK04-1A66B-500W	2242661054	> 1,70	15,0	6,5	9,3	8,5	8,5	17,5	8,0	11,4	10,1	10,1
MK04-1A66C-500W	2243711054	> 2,30	13,0	4,4	7,4	7,2	7,2	16,5	6,5	9,9	9,5	9,5
MK04-1A66D-500W	2244711054	> 2,70	11,0	4,0	5,7	6,5	6,5	14,5	5,5	8,5	9,0	9,0
MK04-1A66E-500W	2245661054	> 3,10	10,0	3,5	4,5	5,7	5,7	13,5	5,0	8,0	8,5	8,5
MK05-1A66B-500W	2252711054	> 1,70	15,0	6,5	9,3	8,5	8,5	17,5	8,0	11,4	10,1	10,1
MK05-1A66C-500W	2253711054	> 2,30	13,0	4,4	7,4	7,2	7,2	16,5	6,5	9,9	9,5	9,5
MK05-1A66D-500W	2254661054	> 2,70	11,0	4,0	5,7	6,5	6,5	14,5	5,5	8,5	9,0	9,0
MK05-1A66E-500W	2255661054	> 3,10	10,0	3,5	4,5	5,7	5,7	13,5	5,0	8,0	8,5	8,5
MK06-4-A	2206040000	< 1,70	18	8,5	15	12	13,5	19	9,5	16	13,5	15
MK06-4-B	2206040001	> 1,70	16	7,5	12,5	10,5	11	17	8	13,5	11,5	12
MK06-4-C	2206040002	> 2,30	14	7	10,5	9,5	9,5	16	7,5	13	11	12
MK06-4-D	2206040003	> 2,70	13	6,5	10	9	9	15	7	11,5	10	10,5
MK06-4-E	2206040004	> 3,10	12	5,5	8,5	8	8	13	6	9,5	9	9
MK12-1A66B-500W	9122711054	> 1,70	18	8	14	13	11,5	20,5	10	17	14,5	13
MK12-1A66C-500W	9123711054	> 2,30	16	6	11,5	9,5	8,5	18	8,5	15	12,5	11,5
MK12-1A66D-500W	9124711054	> 2,70	14	5	7,5	7,5	5,5	17	6,5	11,5	11,5	9,5
MK12-1A66E-500W	9125711054	> 3,10	13	4	5,5	7	3,5	16	6	11	11	8,5
MK11/M8-1A66B-500W	9118266054	> 1,70	15,0	6,5	9,3	8,5	8,5	17,5	8,0	11,4	10,1	10,1
MK11/M8-1A66C-500W	9118366054	> 2,30	13,0	4,4	7,4	7,2	7,2	16,5	6,5	9,9	9,5	9,5
MK11/M8-1A66D-500W	9118066054	> 2,70	11,0	4,0	5,7	6,5	6,5	14,5	5,5	8,5	9,0	9,0
MK11/M8-1A66E-500W	9118566054	> 3,10	10,0	3,5	4,5	5,7	5,7	13,5	5,0	8,0	8,5	8,5
MK13-1A66B-500W	9132661054	> 1,70	15,0	6,5	9,3	8,5	8,5	17,5	8,0	11,4	10,1	10,1
MK13-1A66C-500W	9133711054	> 2,30	13,0	4,4	7,4	7,2	7,2	16,5	6,5	9,9	9,5	9,5
MK13-1A66D-500W	9134711054	> 2,70	11,0	4,0	5,7	6,5	6,5	14,5	5,5	8,5	9,0	9,0
MK13-1A66E-500W	9135661054	> 3,10	10,0	3,5	4,5	5,7	5,7	13,5	5,0	8,0	8,5	8,5
MK14-1A66B-100W	9142711054	> 1,70	15	7	11	10	8	16	8	12	12	9
MK14-1A66C-100W	9143711054	> 2,30	11	5	8	9	6	13	6,5	10	11	7,5
MK14-1A66D-100W	9144711054	> 2,70	10	4	6	6	4,5	12	5	8	8	6,5
MK14-1A66E-100W	9145711054	> 3,10	9	3	4	4	2,5	11	4,5	7	6	5
MK15-B-2	9151710022	> 1,70	14	6,5	7	9	7	16	8	9	9,5	8
MK15-C-2	9151710023	> 2,30	13	6	6,5	8,5	6,5	15	7,5	8,5	9	7,5
MK15-D-3	9151710024	> 2,70	12	5,5	6	7,5	5,5	14	7	8	8,5	7
MK15-E-3	9151710025	> 3,10	11	5	4,5	7	3,5	13	6	7	8	6

Note: The mentioned distances in millimeters in the table are typical values, they can differ in applications.

Notes

Type	Part-No.	Magnetic Sensitivity	Position and Movement max. Pull-in Distance in mm					Position and Movement min. Drop-out Distance in mm				
		mT	D1	D2	D3	D4	D5	D1	D2	D3	D4	D5
MK16-B-2	9161870022	> 1,70	15	7	11	10	9.5	16	8	12	11	11
MK16-C-2	9161870023	> 2,30	13	6	8	8	8	14.5	7	10	10	9.5
MK16-D-2	9161870024	> 2,70	12	5.5	7	7.5	7	14	6.5	9	9.5	9
MK16-E-2	9161870025	> 3,10	11	5	6	7	5.5	13.5	6	9.5	9	8.5
MK17-B-2	9171009022	> 1,70	15	7.5	12.5	10	11	16	8	13.5	11	12
MK17-C-2	9171009023	> 2,30	14.5	7	10	9	9.5	15.5	7.5	11.5	10	10.5
MK17-D-2	9171009024	> 2,70	12.5	6	9.5	8	8	14	7	11	9.5	9.5
MK17-E-2	9171009025	> 3,10	12	5.5	8.5	7.5	7.5	13.5	6.5	10.5	8.5	9
MK18-B-300W	9182100034	> 1,70	16.5	8	14.5	10	12	18.5	9.5	16.5	10.5	14
MK18-C-300W	9183100034	> 2,30	14	7	11	9	9.5	15.5	8	12.5	10	11
MK18-D-300W	9184100034	> 2,70	12	5.5	9	8	7.5	14	7.5	11	9.5	10
MK18-E-300W	9185100034	> 3,10	11	5	7	7	6	13.5	7	10.5	9	9.5
MK20/1-B-100W	9202100014	> 1,70	11	5.5	9	6.5	7.5	11.5	6	10	7	8
MK20/1-C-100W	9203100014	> 2,30	10.5	5	8	6	7	11	5.5	9	6.5	7.5
MK20/1-D-100W	9204100014	> 2,70	10	4.5	7	5.5	6.5	10.5	5	8	6	7
MK20/1-E-100W	9205100014	> 3,10	9.5	4	6	5	6	10	4.5	7	5.5	6.5
MK21M-1A66B-500W	9212100054	> 1,70	13	5.5	4.5	8	3	14	6.5	5.5	9	4
MK21M-1A66C-500W	9213100054	> 2,30	11	4	2.5	6.5	1.5	13	6	4.5	8.5	3.5
MK21M-1A66D-500W	9214100054	> 2,70	9.5	3.5	1	5	1	11.5	5	2.5	7	2
MK21M-1A66E-500W	9215660054	> 3,10	8	2.5	x	4	x	10	3.5	x	6	x

All distance data above are valid for the magnets below:

- 4003004003/open cylindrical magnet, ø 4x19 mm
- 2500000002/M2, screw magnet
- 2500000004/M4, screw magnet
- 2500000005/M5, screw magnet
- 2500000013/M13, screw magnet
- 2500000021/M21, screw magnet

The table on this page contains only part of our sensor product range. Switching distances for other series, switch types, special sensors and with other magnets can be obtained upon request.

Glossary of Commonly used Terms Relating to Reed Switch Products

The following definitions refer to the generally used terms relating to Reed Switches, Reed Sensors, Reed Relays and Electromechanical Relays. Some of the definitions have multiple names. The most popular name was chosen for this listing and is listed under that name. However, we have tried to list those other common names under the most popular name.

Actuation Time is the time from initial energization to the first closing of open contact or opening of a closed contact, not including any bounce.

Ampere Turns (AT or NI) is the product of the number of turns in an electromagnetic coil winding times the current in amperes passing through the winding. AT usually defines the opening and closing points of contact operate conditions.

Armature is the moving magnetic member of an electro-magnetic relay structure.

Bias Magnet is a steady magnetic field (permanent magnet) applied to the magnetic circuit of a relay or sensor to aid or impede operation of the contacts.

Bias, Magnetic is a steady magnetic field applied to the magnetic circuit of a switch.

Blade is used to define the cantilever portion of the reed switch contained within the glass envelope.

Bobbin is a spool, coil form or structure upon which a coil is wound.

Bobbinless Coil (self supporting coil) is a coil formed without the use of a bobbin.

Bounce, Contact is the intermittent opening of closed contacts occurring after initial contact actuation or closure of the contacts due to mechanical rebound, or mechanical shock or vibration transmitted through the mounting.

Break defines the opening of closed contacts.

Breakdown Voltage is that voltage at which an arc or break over occurs between the contacts.

Breakdown Voltage, Pre-ionized is the voltage level at which the voltage breaks down across the contacts, after

which, the voltage had been recently broken down across the contacts, creating an ionized state in the glass capsule. Usually the break-down voltage in the pre-ionized state is a lower value and more repeatable. It is a truer measure of the breakdown voltage level.

Bridging is the undesired closing of open contacts caused by a metallic bridge or protrusion developed by arcing causing the melting and resolidifying of the contact metal.

Changeover Contact (also referred to as a Form C or single pole double throw (SPDT)) has three contact members, one of them being common to the two contacts. When one of these contacts is open, the other is closed and vice versa.

Coaxial Shield is an electrostatic shield grounded at both the input and output.

Coil is an electromagnetic assembly consisting of one or more windings of copper insulated wire usually wound on a bobbin or spool. When current is applied to the coil, a magnetic field is generated, operating the contacts of a Reed Relay or Electromechanical Relay.

Common Mode Voltage usually refers to a voltage level as measured between one or more lines and ground (common) or a current flowing between one or more lines and ground (ground).

Contact refers to the contact blades making up a Reed Switch or Electromechanical Relay.

Contact, Bifurcation is a forked, or branching of contacting member so formed or arranged, as to provide some degree of independent dual contacting.

Contact, Break-before-make (Form C) defines the sequence in which one contact opens its connection to another contact and then closes its connection to a third contact.

Contact Force is the force which two contact points exert against each other in the closed position under specified conditions.

Contact Form describes the type of contacts used for a given design or applications (ex. 1 Form A, 1 Form B, etc.)

Contact, Form A is a single pole single throw (SPST) nor-

mally open (N.O.) switch.

Contact, Form B is a single pole single throw (SPST) normally closed (N.C.) switch.

Contact, Form C is a single pole double throw (SPDT) where a normally closed contact opens before a normally open contact closes.

Contact, Form D is a single pole double throw where the normally open contact closes before normally closed contact opens (continuity transfer).

Contact, Form E is a bistable contact that can exist in either the normally open or normally closed state. Reversing the magnetic field causes the contacts to change their state.

Contact, Current Rating is the current which the contacts are designed to handle for their rated life.

Contact, Gap is the gap between the contact points when the contacts are in the open state.

Contact, Make-before-break (Form D) defines the sequence in which one contact remains connected to a second contact while closing on a third contact and then the second contact opens its connection.

Contact, Rating refers to the electrical load-handling capability of relay contacts under specified conditions for a prescribed number of operations.

Contact, Reed defines a Reed Switch whereby a glass enclosed, magnetically operated contact using thin, flexible, magnetic conducting leads or blades as the contacting members.

Contact Resistance is the electrical resistance of closed contacts; measured at their associated contact terminals after stable contact closure.

Contact Seal refers to a contact assembly sealed in a compartment separate from the rest of the relay.

Contact Separation is the distance between mating contacts when the contacts are open.

Contact, Snap Action describes the crisp closure and opening of contacts at or around the operate points where the contact resistance remains constant and stable.

Contact, Stationary is a member of a contact combination that is not moved directly by the actuating system.

Contact Tip is the point at the end of a contact where the

contacts come together when closed.

Contact Transfer Time (in a Form C switch) is the time during which the moving contact first opens from a closed position and first makes with the opposite throw of the contact.

Contact Weld is a fusing of contacting surfaces to the extent that the contacts fail to separate when intended.

Contact Wipe occurs when a contact is making the relative rubbing movement of contact points after they have just touched.

Contacts, Mercury Wetted are contacts that make closure via a thin film of mercury maintained on one or both contact surfaces by capillary action.

Control Voltage is another name for the voltage applied across the coil of a relay and refers to that point where the relay will operate.

Crosstalk is the electrical coupling between a closed contact circuit and other open or closed contacts on the same relay or switch, expressed in decibels down from the signal level.

Current is the rate of flow of electrons in a circuit measured in amperes (unit A).

Current, AC is alternating current flow from positive to negative.

Current, DC is current flow in one direction.

Current, Carry is the amount of current that can safely be passed through closed switch contacts.

Current, Inrush is the surge of current a load may draw at initial turn on and may be many times greater than the steady current draw.

Current Leakage is that parameter measuring the unwanted leakage of current across open contacts and/or leakage current between the coil and contacts.

Current Rated Contact is the current which the contacts are designed to handle for their rated life.

Currentless Closure refers to contacts closing with no voltage existing or current flowing at the time of closure.

Cycling refers to the minimum number of hours during which a relay may be switched between the off state and the on state at a fixed, specific cycle rate, load current, and case temperature without failure.

De-energize is the act of removing power from a relay coil.

Dielectric Strength or Breakdown Voltage is the maximum allowable voltage, usually measured in DC Volts or Peak AC, which may be applied between two specified test points such as input-output, input-case, output-case and between current-carrying and non-current-carrying metal members.

Dropout refers to maximum value of coil current or voltage at which a Reed Switch or Relay resumes its natural condition.

Dropout Value is the measured current, voltage or distance when the contacts open.

Duty Cycle is the percentage of time on versus time off or duty cycle = Ton/Toff.

Dynamic Contact Resistance is the repetitive measurement of contact resistance measured 1ms to 3 ms after contact closure.

Electrostatic Shield is a copper alloy material terminated to one or more pins and located between two or more mutually insulated elements within a relay which minimizes electrostatic coupling between the coil and Reed Switch in a Reed Relay.

Energization is the application of power to a coil winding of a relay.

Frequency, Operating represents the rate or frequency at which contacts be switched on and off.

Frequency Response is the frequency at which the output signal decreases by 3 dB from the input signal.

Gap, Magnetic describes the nonmagnetic portion of a magnetic circuit.

Hermetic Seal is an encapsulation process where the contacts are sealed in a glass to metal seal in the case of a Reed Switch. In the case of a relay, the contacts and coil are sealed.

Holding Current is the minimum current required to maintain closed contacts.

Holding Voltage is the minimum voltage required to maintain closed contacts.

Hysteresis

1. The lag between the value of magnetism in a magnetic material, and the changing magnetic force producing it; magnetism does not build up at the same rate as the force, and some magnetism remains when the force is reduced to zero. Also, the difference in response of a device or system

to an increasing and a decreasing signal.

2. Hysteresis is also referred to the difference between the operate voltage and the release voltage and can be expressed as a percentage of release/operate.

I/O Capacitance is the capacitance between the input and output terminals or between the coil and contacts.

I/O Isolation Voltage refers to the voltage value before voltage breakdown occurs. It is the same as breakdown voltage.

Impedance refers to the resistance in ohms composed of DC resistance, inductive reactance, and capacitive reactance added vectorally in an RF circuit.

Insulation Resistance is the DC resistance in ohms measured from input to output or across the contacts. Measurement is usually done by applying 100 Volts to one of the points to be measured and the other is connected to a picoameter.

Latching Relay is a relay that maintains its contacts in the last assumed position without needing to maintain coil energization. To change the state of the contacts, the magnetic field must be reversed.

Leakage Current is the current flow from input to output or across the contacts when the contacts are in the open state.

Load, Contact is the electrical power encountered by a contact set in any particular application.

Load Power Factor is the phase angle (cos) between load voltage and load current in an electrical circuit caused by the reactive component of the load.

Load Voltage refers to the supply voltage range at the output used to normally operate the load.

Low Thermal Relay is a Reed Relay designed specifically to switch very low microvolt or nanovolts signals without distorting their signal level.

Magnetic Flux is the total magnetic induction, or lines of force, through a given cross section of a magnetic field.

Magnetic Interaction is the undesired effect when relays are mounted in close proximity, the flux produced when the coils are energized affects the pickup and dropout values of the adjoining relays. This either increases or decreases both pickup and dropout values. The direction of the parameter shift is determined by whether the stray flux aids or bucks the flux produced by the coil of the relay under consideration. Problems may result from bucking flux raising the pickup

voltage close to the coil drive voltage or by aiding the flux of sufficient magnitude that the relay will not drop out when its drive is removed. To calculate the change in pull-in voltage and dropout voltage, multiply the percent change shown by the relay's nominal voltage. For example, if the percent change in pull-in voltage is 14% for a 5V nominal relay, the pull-in voltage will increase by 0.7 volts.

Magnetic Pole is the end of a magnet, where the lines of the flux coverage, and the magnetic force is strongest (north or south pole).

Magnetic Shield is a thin piece of ferromagnetic metal surrounding a relay to enhance its magnetic field internally while reducing the stray magnetic field external to the relay.

Magnetostrictive Force usually refers to the force produced on the contacts with current flowing and the coil energized. Here the magnetic field of the coil and the magnetic field produced by the current flowing through the contacts interact with each other producing a torsional force.

Make refers to the closure of open contacts.

Mechanical Shock, Non-operating is the mechanical shock level (amplitude, duration and wave shape) to which the relay or sensor may be subjected without permanent electrical or mechanical damage (usually during storage or transportation).

Mechanical Shock, Operating is the mechanical shock level (amplitude, duration and wave shape) to which the relay or sensor may be subjected without permanent electrical or mechanical damage during its operating mode.

Miss, Contact is the failure of a contact mating pair to close in a specified time or with a contact resistance in excess of a specified maximum value.

MOV (Metal Oxide Varistor) is a voltage-sensitive, non-linear resistive element. MOV's are clamp-type devices that exhibit a decrease in resistance as the applied voltage increases. They are usually characterized in terms of the voltage drop across the device while it is conducting one milliamp of current. This voltage level is the conduction threshold. The voltage drop across an MOV increases significantly with device current. This factor must be taken into consideration when determining the actual protection level of the device in response to a transient.

Normally Closed (N.C.), Contacts (Form B) represents a state of contacts before any magnetic field is applied to them in which they exist in the closed state.

Normally Open (N.O.), Contacts (Form A) represents a state of contacts before any magnetic field is applied to them in which they exist in the open state.

OHM's Law the following is a table of common electrical conversions

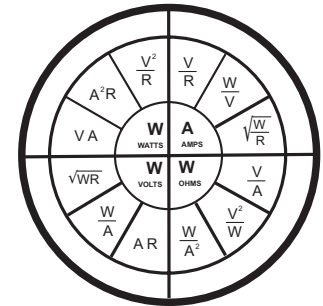

Operate Time or (contact operate time or Pull-in time) is the total elapsed time from the instant power is applied to the energizing coil until the contacts have operated and all contact bounce has ended.

Operating Temperature Range is the normal temperature range in which a Reed Switch, Sensor, or Relay will successfully operate.

Output is the portion of a relay which performs the switching function required.

Output Capacitance is capacitance across the contacts.

Output Offset Voltage or thermal offset usually measured in microvolts is voltage existing across closed contacts in the absence of any signals. The voltage which appears at the output of the isolation amplifier with the input grounded.

Overdrive is the amount of voltage or ampere turns applied after the exact point of closure of contacts is reached. Contact resistance is usually measure with 40 % overdrive.

Permeability is a characteristic of a magnetic material which describes the ease of which it can conduct magnetic flux.

Pickup Value refers to the measure of current or voltage applied to a relay when the contacts just close.

Pickup Pulse is a short, high-level pulse applied to a relay; usually employed to obtain faster operate time.

Pole, Double is a term applied to a contact arrangement to denote two separate contact combinations, that is, two single-pole contact assemblies

Pole, Single is a term applied to a contact arrangement to denote that all contacts in the arrangement connect in one position or another to a common state. Pressure, Contact refers to the force per unit area on the contacts.

Rating, Contact is the maximum rating of the allowable voltage and current that a particular contact is rated to switch.

Reed Relay is a relay that uses a glass-enclosed hermetically sealed magnetic reed as the contact members.

Reed Switch or Reed Sensor is a switch or relay using glass-enclosed magnetic reeds as the contact members which includes mercury-wetted as well as dry contact types.

Relay, Antenna switching is a special RF relay used to switch antenna circuits.

Relay, Close Differential is a relay having its drop-out value specified close to its pickup value.

Relay, Crystal Can defines a relay housed in a hermetically sealed enclosure that was originally used to enclose a frequency control type of quartz crystal.

Relay, Current Sensing is a relay that functions at a predetermined value of current typically used in teleco Reset refers to the return of the contacts to their normal state (initial position).

Resonant Frequency is the tendency of the contacts to resonate at certain frequencies determined by their size and makeup.

Retentivity is the capacity for retaining magnetism after the magnetizing force is removed.

Saturation exists when an increase of magnetization applied to a magnetic material does not increase the magnetic flux through that material.

Sensitivity refers to the pull-in of a Reed Switch usually expressed in ampere-turns.

Shield, Electrostatic is the grounded conducting member located between two or more mutually insulated elements to minimize electrostatic coupling.

Slew Rate is the rate of change in output voltage with a large amplitude step function applied to the input.

Small Signal Bandwidth is the frequency range from DC to a frequency where the signal strength is down 3 dB from its original signal strength.

Thermal Offset usually measured in microvolts is the voltage existing across closed contacts in the absence of any signals.

Thermal Shock Non-operating is the temperature shock induced into a group of Relays, Switches or Sensors to determine their robustness.

Turn Off or Dropout Time refers to the time from initial de-energization to the first opening of a closed contact time.

Turn On or (contact operate time or Pull-in time) is the total elapsed time from the instant power is applied to the energizing coil until the contacts have operated and all contact bounce has ended.

Varistor see MOV.

Vibration, Non-operating is the vibration level and frequency span to which the relay may be subjected without permanent electrical or mechanical damage.

Voltage, Nominal is the typical voltage intended to be applied to the coil or input.

Voltage, Peak AC is the maximum positive or negative voltage swing of an alternating current signal or power supply.

Voltage, Peak to Peak AC is the maximum positive through negative voltage swing of an alternating current signal or power supply. $V_{p-p} = 2V_p$ when no DC offset is present.

Voltage, RMS is the Root Mean Square of the positive and negative voltage swing of an alternating current signal or power supply.

Winding refers to the electrically continuous length of insulated wire wound on a bobbin, spool or form.

Winding, Bifilar represents two windings with the wire of each winding alongside the other, matching turn for turn.

Wipe, Contact refers to the sliding or tangential motion between two mating contact surfaces as they open or close.

Notes

Notes

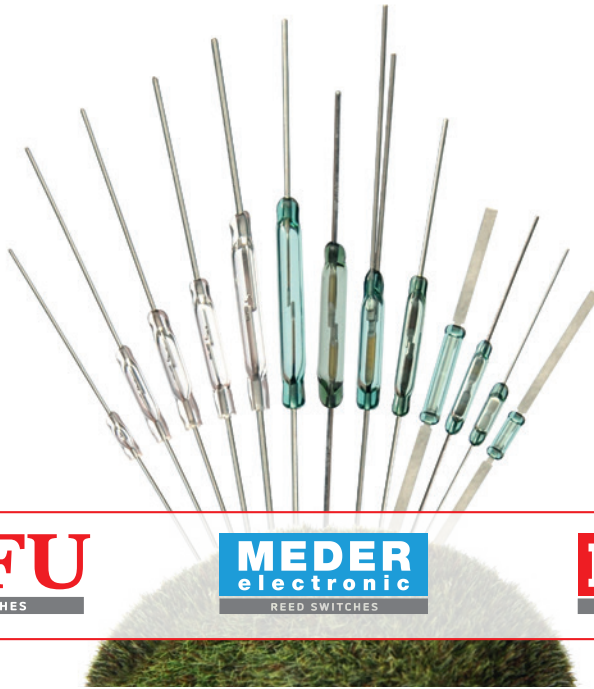

3 LEADING BRANDS

KOFU
REED SWITCHES

MEDER
electronic
REED SWITCHES

KENT
REED SWITCHES

Contact Information:

Standex Electronics
World Headquarter
4538 Camberwell Road
Cincinnati, OH 45209 USA

Standex Americas (OH)
(+1.866.782 .6339)
+1.866.STANDEX
info@standexelectronics.com

Standex Asia (Shanghai)
+86.21.37606000
salesasia@standexmeder.com

Standex Europe (Germany)
+49.7731.8399.0
info@standexmeder.com