

Application Alley

No Power Switching Solutions

*Switching Solutions Requiring Little or No Power to Operate
Using Reed Sensor/Relay Technology*



Standex
Electronics
PARTNER | SOLVE | DELIVER®

Introduction

Power consumption in today's electronic market is a concern with the dramatic increase in the use of portable electronic gadgetry. Power hungry components are rapidly being designed out in favor of power efficient products. Normally closed (Form B) Reed Sensors and Reed Relays draw zero power in their normally closed states. A latching Reed Relay uses minimal power for its operation in 'setting' or 'resetting' the contact states (bi-stable); and for that reason have attracted the interest of power efficient designers. Latching Reed Switches and sensors (bi-stable) in a similar manner, use simple movement of a permanent magnet to change the state of reed contacts with absolutely no electrical power usage. In critical applications where contact s must function even when power is lost; reed technology may often be the best approach in many of these applications.

Applications

- Battery operated electronics requiring switching functions
- Safety circuits requiring a normally closed switch drawing no power that will only be activated (opening the circuit) when a fault condition develops
- Applications where the switching function is closed for a long time drawing no power
- Applications where the switching function is either open or closed for long periods of time and draws no power while in either state
- Low microvolt offset requirements
- Portable electronic equipment
- Elevator controls
- Transport and stocking environments
- Switching functions required in a 'no power' or 'lost power' requirement
- Security and alarm systems
- Home appliances
- And many more

To properly understand the functioning of reed tech-

nology in the configurations below, it is first important to understand the basics of the Reed Switch.

1. Normally closed Reed Sensors
2. Normally closed Reed Relays
3. Latching (bi-stable) Reed Switches/Sensors
4. Latching (bi-stable) Reed Relays

Form A Reed Switch

Reed Switches exist in their natural state in the normally open condition. This is typically referred to as single pole normally open, single pole single throw (SPST), or Form A (see Figure 1).

The two Reed Switch leads are ferromagnetic and are hermetically sealed in a glass capsule. When the normally open Reed Switch is subjected to a mag-

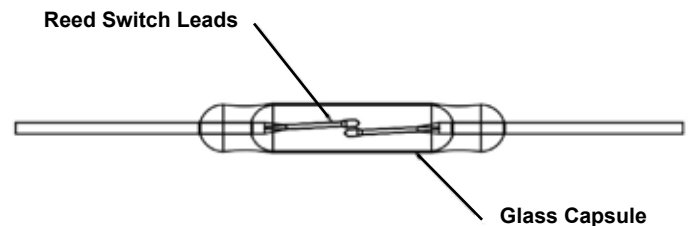

Figure 1. Normally Open Reed Switch

netic field the contacts will close (see Figure 2). The contacts will stay closed as long as the magnetic field remains. Once the magnetic field is removed the contacts will open. Here energy is expended the entire time the contacts are in the closed state, making it less ideal from a power consumption standpoint.

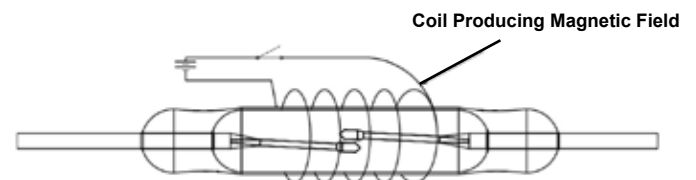

Figure 2. The Form A Reed Switch contacts have closed in the presence of a magnetic field.

Form C Reed Switch

Another type of Reed Switch is the single pole double throw (SPDT) or Form C Reed Switch (see Figure 3).

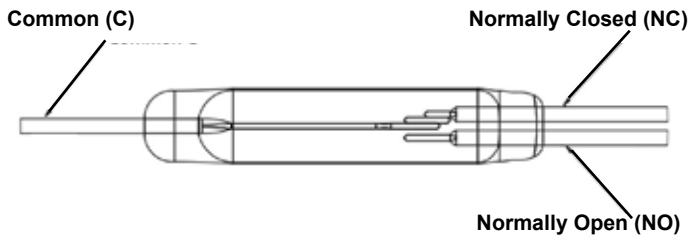

Figure 3. Form C Reed Switch in its un-energized position.

In Figure 3, no magnetic field is present therefore the common contact maintains its connection to the normally closed contact. The Reed Switch draws no power while in its normally closed state. When a magnetic field is applied, the Reed Relay draws 100% power while the common reed element swings from the normally closed to the normally open contact (see Figure 4). Once the magnetic field is removed the common contact swings back to the normally closed contact.

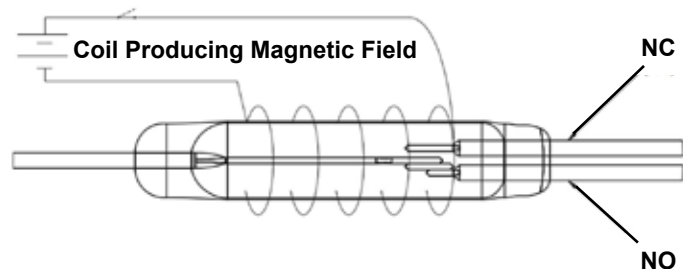

Figure 4. Form C Reed Switch showing its changed state in the presence of a magnetic field.

Normally Closed (Form B) Reed Switches & Sensors

Since the natural state of a form A Reed Switch is normally open, we need to apply a permanent magnet to the Reed Switch sufficient in its magnetic strength to close the reed contacts (See

Figure 5). The biasing magnet must be greater than the Pull-in or operate milliTesla (mT) field that closes the contacts in the normally open condition.

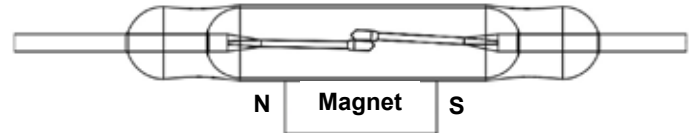

Figure 5. A Form A Reed Switch is biased closed using a permanent magnet.

At this stage, the polarity of the magnet does not matter. However, to open the contacts a permanent magnet must be brought into the proximity of the biasing magnet with an opposite polarity and sufficient magnetic strength equal to, or stronger than the biasing magnet to open the contacts (see Figure 6).

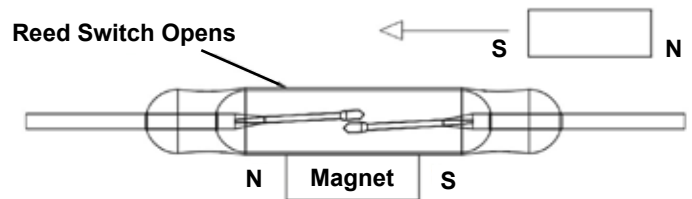

Figure 6. The normally closed, Form A Reed Switch opens in the presence of an offsetting magnetic field of opposite polarity.

Normally Closed (Form B) Reed Relays

Several applications call for a Reed Relay to have its contacts closed for long periods of time, only opening when a fault condition occurs. The normally closed (Form B) Reed Relay was designed for just such an application. Furthermore, in the closed position, the relay coil draws no power making it amenable to battery operated devices and/or requirements where little power is available. Figure 7 shows the schematic configuration of a Form B Reed Relay in its un-energized normally closed state.

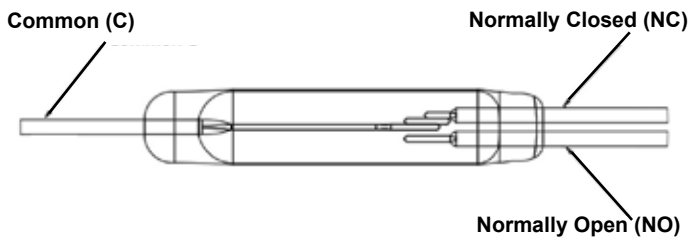

Figure 7. A Form B Reed Relay in its off state where the contacts are closed.

Applying power to the coil producing a magnetic polarity that opposes the polarity to the biasing magnet, and of sufficient magnetic strength to overcome the field strength of the biasing magnet, will cause the contacts to open (see Figure 8).

The Form B Sequence

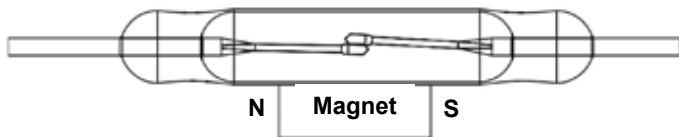

Figure 8. An energized Form B where the coil power is sufficient to overcome the field strength of the permanent magnet opening the contacts.

Shown in Figure 9 is the step-by-step sequence of the operation of a Form B Reed Relay. First, a Reed Switch is selected having an operate (Pull-in) of 4 mT and a release (Drop-out) of 2 mT. Next a biasing magnet is added having a field strength of 5 mT incident on the Reed Switch. Since this field strength is above the

Pull-in point of the Reed Switch, the contacts will close as shown at point 1 in the graph. Next the coil applies an opposing magnetic field of 4 mT. The net result of the two magnetic fields is 1 mT. This net field strength is below the Drop-out of the Reed Switch, causing the contacts to open, as illustrated at point 2. Finally the coil is turned off and the contacts will close because the magnetic field strength is back to 5 mT.

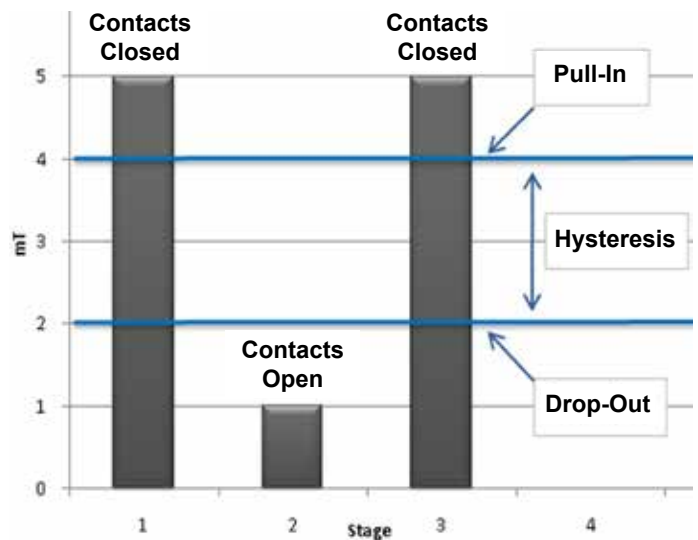

Figure 9. A step-by-step approach showing a full operation cycle of a Form B Reed Relay.

The voltage polarity of the coil applied to the Form B relay determines the magnetic polarity of the coil. This voltage polarity is determined by design and the polarity is marked on the relay. Applying a reverse voltage polarity will cause the relay to malfunction until the correct polarity is applied. Also, too high a voltage applied above the specified nominal voltage can cause the contacts to re-close. Generally, the re-close voltage is specified at 50% above the nominal. Essentially this means that applying above 7.5 volts for a 5 volt nominally rated Form B relay could cause the contacts to re-close. If this is ever a concern with a user where their circuit may produce voltages greater than 50% above the nominal, relay designers can make adjustments to the magnetic design to increase the specified re-close voltage.

Latching Reed Relays/Reed Sensors

A latching Reed Relay/Reed Sensor by definition, can exist in two states: the unlatched or open state and the latched or closed state. When in either state, no power is required to keep the Reed Switch in that state.

Latching is made possible by the natural hysteresis that exists between the operate (Pull-in) and release (Drop-out) points of the Reed Switch (See Figure 10). As shown in Figure 10, the higher the operate point the larger the hysteresis. The larger the hysteresis, the easier it is to establish the latch and unlatch points from a design standpoint. A permanent magnet is required to bias the Reed Switch allowing it to operate in the latching mode. This will be seen in the discussion that follows.

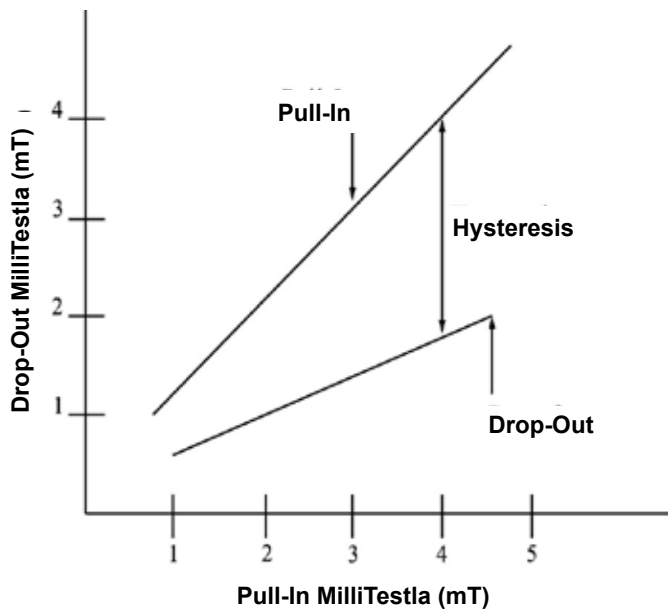

Figure 10. A graph of the operate (Pull-in) and release (Drop-out) points in milliTesla showing the hysteresis.

Latching Reed Relay

A latching Reed Relay uses a Form A Reed Switch in conjunction with a permanent magnet. (see Figure 11).

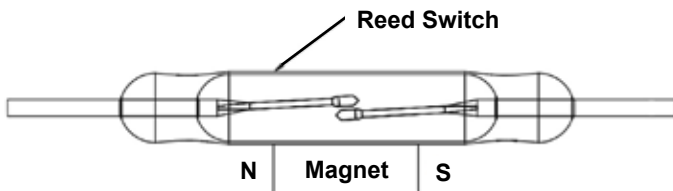

Figure 11. A Form A Reed Switch is magnetically biased by the presence of a permanent magnet.

In this state, the Reed Switch may be in its normally

open state or its normally closed state. The state it is in, depends upon the previous magnetic field it had last seen. If open, when a magnetic pulse with the correct magnetic polarity is applied, the contacts will change to the normally closed state. (see Figure 12). Once the pulsed magnetic field is gone, the Reed Switch will remain in its closed state until another

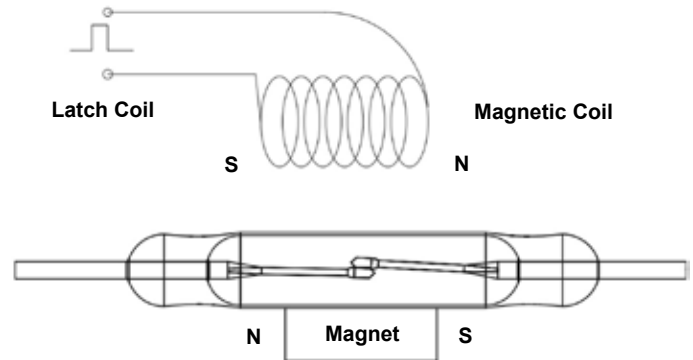

Figure 12. Latching Reed Relay showing the magnetic pulse changing the state of the Reed Switch closed.

magnetic pulse with the opposite magnetic polarity is applied (see Figure 13). While in this closed state, there is no power consumed for as long as it is in this state.

Pulsing the coils of latching Reed Relays in conjunc-

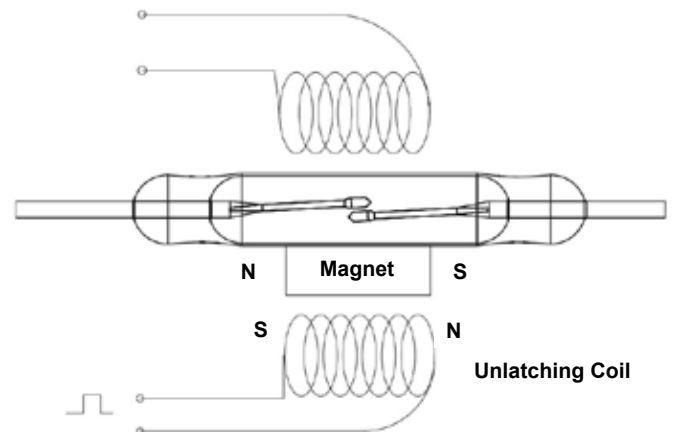

Figure 13. A magnetic pulse of opposite polarity in Figure 11 opens the contacts.

tion with the biasing magnet to close and open the reed contacts, uses negligible power.

Generally a 2ms pulse supplied at the relay nominal voltage is enough to change the state of the relay contacts. Therefore, heat generated when closing and opening the relay contacts is minimal thereby producing minimal thermal offset voltages.

The Latching & Unlatching Sequence

For a better understanding of exactly how the latching and unlatching occurs, we have selected a Reed Switch that has an operate point (contact closure) when a field of 4mT is applied; and a release point (contacts open) at 2 mT or below. We have set the biasing magnet for a magnetic field strength of 3 mT. In Figure 14 we have sequentially chosen a full operate cycle, showing all the operate states. As can be seen the pull-in and drop-out points do remain constant and are shown as constant lines.

The five stages and Reed Switch contact state are outlined below:

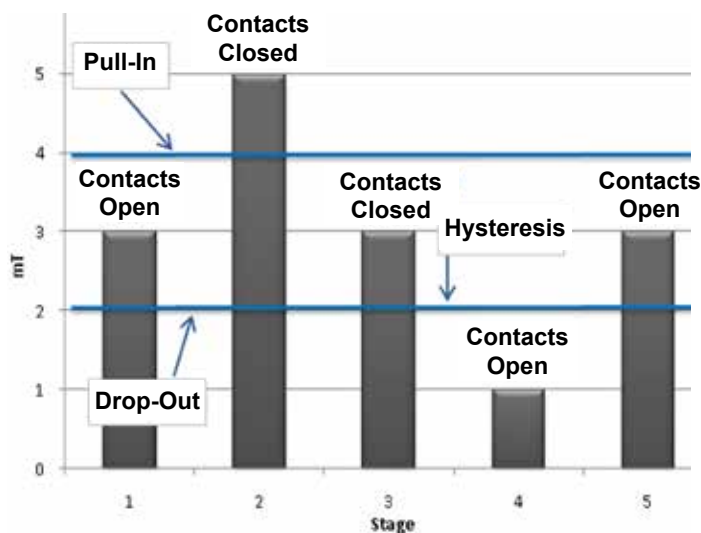

Figure 14. For a given Reed Switch having a pull-in of 4mT and a drop-out of 2mT, a complete cycle is presented in five stages showing how it can be latched and unlatched.

- Stage 1: Here the biased magnetic field (BMF) which is always present and applied to the Reed Switch is shown at the 3 mT level. The contacts are open.

- Stage 2: An external magnetic field (EMF) (this could be from a coil or permanent magnet) is applied producing a 2 mT magnetic field aiding the biasing magnet's field (BMF). This puts the magnetic field applied to the Reed Switch at 5 mT, which is above the 4 mT level, therefore closing the contacts.
- Stage 3: Now the EMF is removed leaving only the BMF. But as one can see, the field strength is still above the drop out field, so with the EMF removed the contacts stay closed.
- Stage 4: The EMF is again applied, but this time the field is opposing the BMF bringing the net magnetic field strength to 1mT. Now the field is below the Drop out level and the contacts open.
- Stage 5: The opposing EMF is now removed leaving only the BMF and the reed contacts stay in the open state.

In this manner one can latch and unlatch the contacts.

The cycle above clearly illustrates that latching Reed Relays require magnetic polarity reversal in order to change the state of the contacts, which can either be accomplished using two coils as shown above or by reversing the polarity of a single coil. In the former case it adds more cost to the relay having a double coil; and in the latter case more electronic circuitry is required to change the polarity for each contact state change.

Using Latching Reed Switches

Latching Reed Switches are used in the same manner as above, in Figure 11, where the Reed Switch is biased with a permanent magnet; however, instead of using a coil, as shown in Figures 12 and 13, another permanent magnet is used with a different polarity as shown in Figure 15.

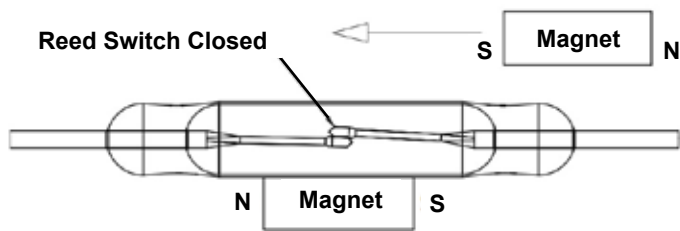

Figure 15. A permanent magnet is brought into proximity of the reed and biasing magnet closing the contacts.

In this case, when the permanent magnet is removed, the contacts stay closed and will remain closed until a permanent magnet is brought into proximity to the reed and biasing magnet with an opposite polarity. This is similar to the latching Reed Relay above. The use of permanent magnets uses no electrical power at all; and therefore eliminates the need for power supplies, electrical circuits and timing circuits. The state of the Reed Switch uses no power (unlike Hall sensors) and relies strictly on the movement of magnets in and out of its influence. Also similar to the latching Reed Relay, one or two magnets can be used in changing the contact state.

- Using one magnet: Once a permanent magnet has been brought into proximity to the Reed Switch the contacts close. When the permanent magnet is then withdrawn the contacts remain closed. The permanent magnet will then need to be rotated, reversing its magnetic polarity. When it is then brought into the proximity of the reed and biasing magnet again, it will open the contacts (see Figure 16).
- Using two magnets: latching and unlatching can be accomplished by having one magnet approach one direction closing the contacts and then withdrawn. The opposing magnet then approaches from the other direction showing an opposite polarity and thereby opening the contacts. This can be done effectively in several ways depending upon the type of movement for a given application.

Latching Reed Switches can require a fine balancing of the magnetic system, particularly when there are

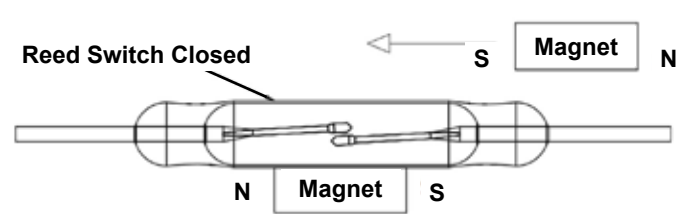

Figure 16. A permanent magnet with opposite polarity brought into proximity of the reed and biasing magnet opens the contacts.

other ferromagnetic materials nearby. An application requiring latching Reed Switches can undoubtedly be the best design choice; however, we recommend having MEDER engineers and sales engineers work closely with you for best results. There are many ways to accomplish the latching environment, so for a given set of circumstances, our engineers will come up with a professional, simple, and cost effective approach.

Summary

When the contacts are expected to be in the closed state for long periods of time and consumption power is a serious condition, using a Form B Reed Sensor or Reed Relay may be the best option. When power is a consideration, whether in the open or closed state, a latching Reed Switch or latching Reed Relay may be the best option.

The latching Reed Switch is the only sensor technology where no power is necessary for operation and release of the contacts. With increased demand for low power components, the latching or normally closed aspect of a Reed Switch stands by itself.

Find out more about our ability to propel your business with our products by visiting www.standexelectronics.com or by giving us a hello@standexelectronics.com today! One of our brilliant engineers or solution selling sales leaders will listen to you immediately.

About Standex Electronics

Standex Electronics is a worldwide market leader in the design, engineering, and manufacture of standard and custom electro-magnetic components, including magnetics products and reed switch-based solutions.

Our magnetics offerings include planar, current sense, and conventional low- and high-frequency transformers and inductors. Reed switch-based solutions include Meder, Kent, and KOFU brand reed switches, as well as a complete portfolio of reed relays, and a comprehensive array of fluid level, proximity, motion, water flow, HVAC condensate, hydraulic pressure differential, capacitive, conductive and inductive sensors.

We offer engineered product solutions for a broad range of product applications in the transportation, automotive, medical, test and measurement, military and aerospace, aviation, HVAC, appliance, security and safety, and general power and industrial markets.

Standex Electronics has a commitment to absolute customer satisfaction through a partner, solve, and deliver approach. With a global organization that offers sales support, engineering capabilities, and technical resources worldwide – we implement customer driven innovation that puts the customer first.

For more information on Standex Electronics, visit us on the web at standexelectronics.com.

Contact Information:

Standex Electronics

World Headquarters
4538 Camberwell Road
Cincinnati, OH 45209 USA

Standex Americas (OH)

+1.866.STANDEX (+1.866.782.6339)
info@standexelectronics.com

Standex Electronics Asia (Shanghai)

+86.21.37606000
salesasia@standexelectronics.com

Standex Electronics Europe (Germany)

+49.7731.8399.0
info@standexelectronics.com

Standex Electronics India (Chennai)

+91.98867.57533
kkasaragod@standexelectronics.com

Standex Electronics Japan (Kofu)

+81.42.698.0026
sej-sales@standex.co.jp

